



TELEFLEX PAEDIATRIC PRODUCTS

Only the best is good enough for children





TELEFLEX – ONLY THE BEST IS GOOD ENOUGH FOR CHILDREN

It is a well-known fact that children aren't just miniature adults and cannot be treated as such. Anatomical and physiological differences are associated with different age-groups and stages of maturation. Special paediatric skills, training, experience and the application of devices suitable for children are essential when caring for children under the age of six – particularly in intensive care.

Teleflex never stops engineering products that earn your and your patients' confidence. Trusted brands, a wealth of know-how and proven technologies will help you to meet the diversified challenges that arise in the field of paediatrics. We can offer the optimum solution to meet your requirements, whether the application is in anaesthesiology, critical care, urology and surgery, or cardiac care. Moreover, it is our overall aim to reduce infections and improve patient safety with every single product we manufacture.

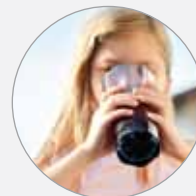

I ARTERIAL & VENOUS ACCESS	4
Central Venous Catheters.....	5
Arterial Catheterisation	8
Right Heart Products	10
II FILTRATION & HUMIDIFICATION	16
Active Humidification	17
Passive Humidification	20
Combined HMEF.....	23
Bacterial/Viral Filters.....	24
III THORAX DRAINAGE SYSTEMS	26
IV OXYGEN & AEROSOL THERAPY	30
Masks / Nasal Cannulas.....	31
Prefilled Humidifiers / Nebulisers.....	34
Small Volume Nebulisers.....	36
V TRACHEOSTOMY	38
Armoured Tracheostomy Tubes.....	39
Standard Tracheostomy Tubes	44
Preshaped Tracheostomy Tube.....	46
Special Products	47
Accessories.....	48
VI AIRWAY MANAGEMENT	50
Cold Light Laryngoscopes	51
Endotracheal Tubes.....	55
Laryngeal Masks	65
Oropharyngeal & Nasopharyngeal Airways	67
Anaesthesia Masks / Rebreathing Bags	69
Circuits	74
Catheter Mounts.....	79
Accessories.....	80
VII REGIONAL ANAESTHESIA	82
VIII UROLOGY	84
Foleys.....	85
Suprapubic Catheters.....	87
Urine Collectors	90
Ureteral Stents.....	91
IX SURGERY	94
Laparoscopic Surgery	95
Ports & Needles.....	96
Gastroenterology.....	99
X TEMPERATURE MANAGEMENT	100
Temperature Foley	101
Convective Warming System	102



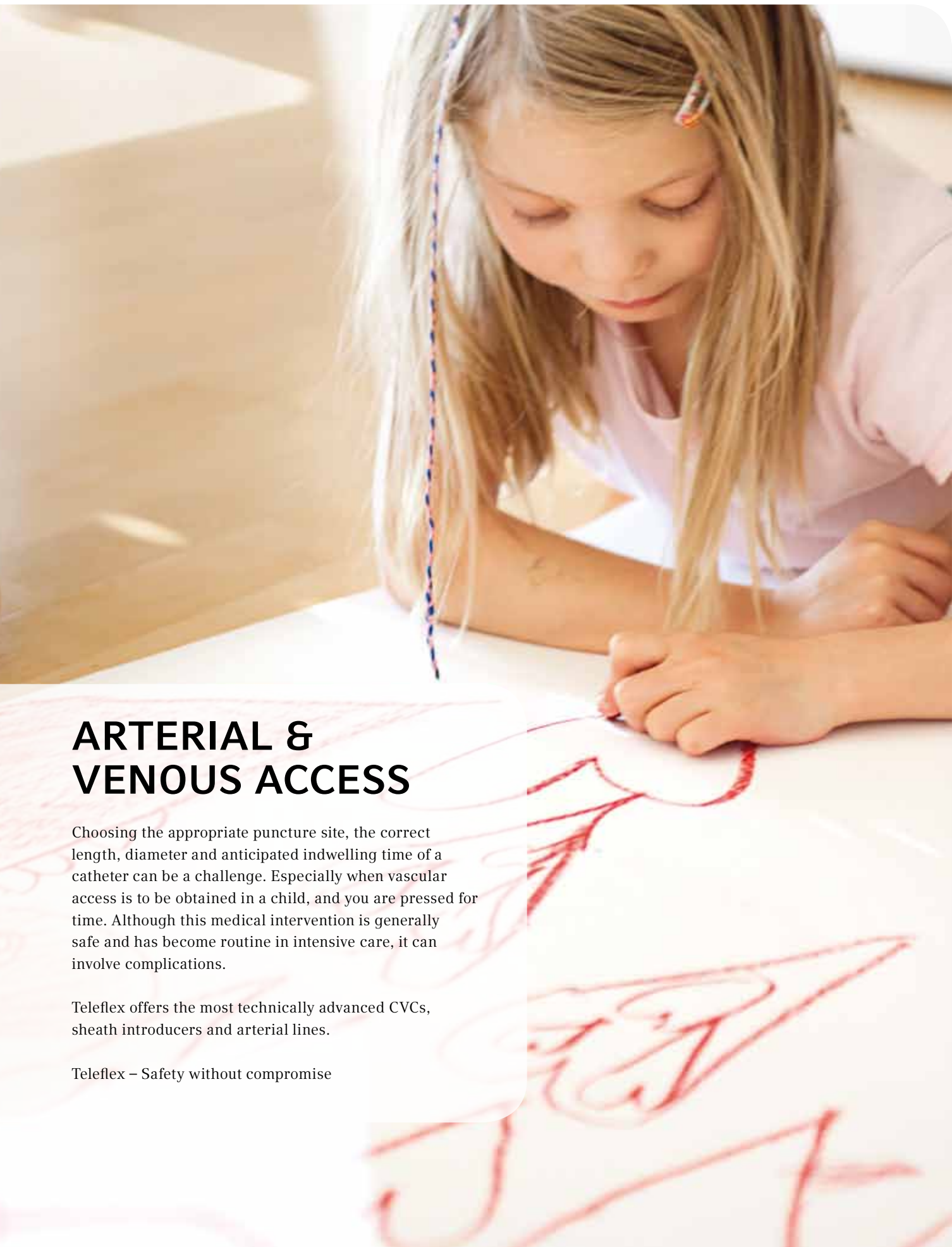

ARTERIAL & VENOUS ACCESS

Choosing the appropriate puncture site, the correct length, diameter and anticipated indwelling time of a catheter can be a challenge. Especially when vascular access is to be obtained in a child, and you are pressed for time. Although this medical intervention is generally safe and has become routine in intensive care, it can involve complications.

Teleflex offers the most technically advanced CVCs, sheath introducers and arterial lines.

Teleflex – Safety without compromise

CENTRAL VENOUS CATHETERS

Teleflex's ARROW CVCs are the first choice for venous access with either unprotected standard catheters or catheters using antimicrobial technology. ARROWg+ard's ability to reduce infection, save lives and reduce costs has been demonstrated in more than 30 studies.¹ A special

catheter design (L, M, N) responds especially well to the needs of children. Designed to soften in situ, high-quality, radiopaque polyurethane enhances indwelling characteristics. The moulded, flexible low-profile junction hub increases patient comfort and eases maintenance.

1-LUMEN CENTRAL VENOUS CATHETERS



LUMEN DESIGN



1-LUMEN CVC

ARROW

REF.	LENGTH CM	Ø GA.	DESIGN	MATERIAL	SPRING-WIRE GUIDE		INSERTION METHOD			SYRINGE	ACCESSORIES	QTY
					LENGTH CM	Ø MM (INCH)	SELDINGER	LENGTH CM	CATHETER OVER NEEDLE ASSEMBLY	STANDARD LUER-SLIP	SCALPEL	
AK-04650-E* (w/o wings)	9	24	A	PUR	35	0.46 (0.018")	21 G	3.81		3 ml – LL	x	10
ES-04650* (w/o wings)	9	24	A	PUR	35	0.46 (0.018")	21 G	3.81		3 ml – LS		10
AK-04660* (w/o wings)	12	24	A	PUR	35	0.46 (0.018")	21 G	3.81		3 ml – LL	x	10
ES-04522	10	22	A	PUR	35	0.53 (0.021")	21 G	3.81		5 ml – LS		10
ES-04150*	12	20	A	PUR	35	0.64 (0.025")	20 G	5.08		3 ml – LS		10
AK-04150-E*	12	20	A	PUR	35	0.64 (0.025")	20 G	3.81	20G	3 ml – LL	x	10
ES-04218*	20	18	A	PUR	45	0.64 (0.025")	18 G	6.35		5 ml – LS		10

* without extension

¹ Veenstra, D.L., Sint, S., Saha, S., Lumley, T., Sullivan, S.D. "Cost-Effectiveness of Antiseptic-Impregnated Central Venous Catheters for the Prevention of Catheter-Related Bloodstream Infection," *Journal of the American Medical Association*, January 20, 1999, Vol. 281, Issue 3, pp. 261-267

2-LUMEN CENTRAL VENOUS CATHETERS

- soft catheter tip (Blue Flex Tip) balances insertion capability with indwelling performance
- available in different diameters and lengths
- available with ARROWg⁺ard impregnation

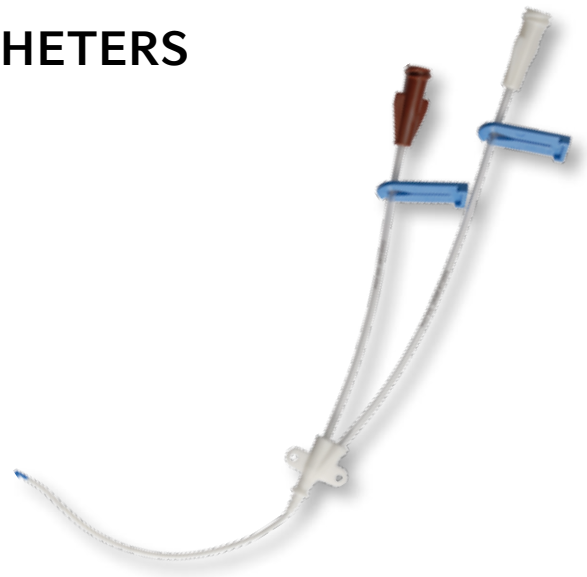
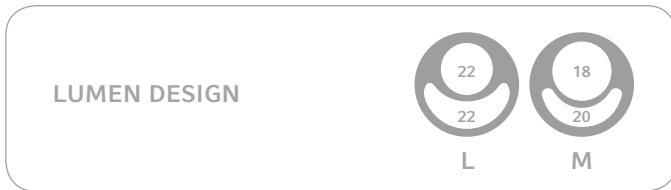

2-LUMEN CVC WITH BLUE FLEX TIP

ARROW

REF.	CATHETER					SPRING-WIRE GUIDE			INSERTION METHOD				SYRINGE	QTY
	Ø FR.	LENGTH CM	Ø GA.	DESIGN	MATERIAL	LENGTH CM	Ø MM (INCH)	LENGTH MARKER	SELDINGER	LENGTH CM	CATHETER OVER NEEDLE ASSEMBLY	LENGTH CM		
CS-12402	4	5	22-22	L	PUR	45	0.46 (0.018")		21	3.81	22	4.45	5 ml – LS	5
CS-15402-E	4	8	22-22	L	PUR	45	0.46 (0.018")		21	3.81	22	4.45	5 ml – LS	5
CS-25402	4	8	22-22	L	PUR A+g	45	0.46 (0.018")	x	21	3.81	22	4.45	5 ml – LS	5
CS-14402	4	13	22-22	L	PUR	45	0.46 (0.018")		21	3.81	22	4.45	5 ml – LS	5
ES-14402	4	13	22-22	L	PUR	45	0.46 (0.018")		22	2.67			5 ml – LS	5
ES-24402	4	13	22-22	L	PUR A+g	45	0.46 (0.018")		22	2.67			5 ml – LS	5
CS-24402	4	13	22-22	L	PUR A+g	45	0.46 (0.018") PTFE coated		21	3.81	22	4.45	5 ml – LS	5
CS-16402	4	30	22-22	L	PUR	68	0.46 (0.018")		21	3.81	22	4.45	5 ml – LS	5
CS-22502	5	5	20-18	M	PUR A+g	45	0.53 (0.021") PTFE coated		20	3.81	20	4.45	5 ml – LS	5
CS-25502	5	8	20-18	M	PUR A+g	45	0.53 (0.021") PTFE coated		20	3.81	20	4.45	5 ml – LS	5
CS-14502	5	13	20-18	M	PUR	45	0.53 (0.021")		20	3.81	20	4.45	5 ml – LS	5

3-LUMEN CENTRAL VENOUS CATHETERS

- soft catheter tip (Blue Flex Tip) balances insertion capability with indwelling performance
- available in different diameters and lengths
- available with ARROWg⁺ard impregnation

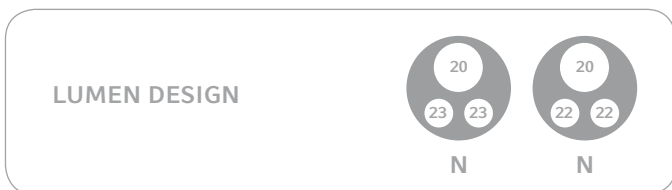
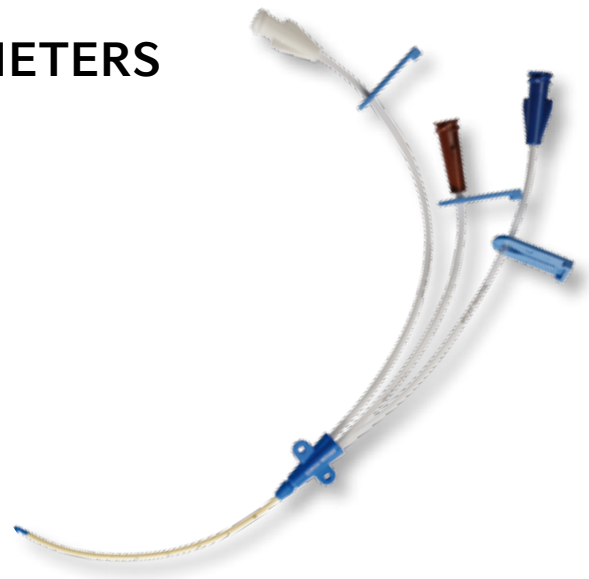

3-LUMEN CVC WITH BLUE FLEX TIP

ARROW

REF.	CATHETER					SPRING-WIRE GUIDE			INSERTION METHOD			SYRINGE	QTY
	Ø FR.	LENGTH CM	Ø GA.	DESIGN	MATERIAL	LENGTH CM	Ø MM (INCH)	LENGTH MARKER	SELDINGER	LENGTH CM	CATHETER OVER NEEDLE ASSEMBLY		
CS-14403	4	13	20-23-23	N	PUR	45	0.46 (0.018")		21	3.81	22	5 ml – LS	5
CS-15403	4	8	20-23-23	N	PUR	45	0.46 (0.018")		21	3.81	22	5 ml – LS	5
CS-12553-J	5.5	5	20-22-22	N	PUR	45	0.46 (0.018")		21	3.81	22	5 ml – LS	5
CS-14553	5.5	30	20-22-22	N	PUR	68	0.46 (0.018")		21	3.81	22	5 ml – LS	5
CS-15553-E	5.5	8	20-22-22	N	PUR	45	0.46 (0.018")		21	3.81	22	5 ml – LS	5
CS-25553	5.5	8	20-22-22	N	PUR A+g	45	0.46 (0.018")	x	21	3.81	22	5 ml – LS	5
CS-16553-E	5.5	13	20-22-22	N	PUR	45	0.46 (0.018")		21	3.81	22	5 ml – LS	5
CS-16553-J*	5.5	13	20-22-22	N	PUR	45	0.46 (0.018")		21	3.81	22	5 ml – LS	5
CS-26553	5.5	13	20-22-22	N	PUR A+g	45	0.46 (0.018")	x	21	3.81	22	5 ml – LS	5
CV-15553	5.5	30	20-22-22	N	PUR	45	0.46 (0.018")	x	21	3.81		5 ml – LS	10

* reduced exit port distances from catheter tip

LARGE BORE CATHETER

- specially designed for haemofiltration
- offering the option for high-volume infusions
- incl. Arrow Raulerson syringe: patented technology, for reduced risk of blood exposure and air embolism

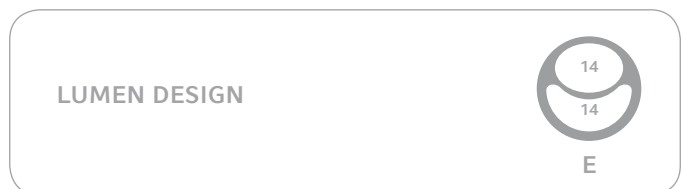

2-LUMEN LARGE BORE CATHETER

ARROW

REF.	CATHETER					SPRING-WIRE GUIDE			INSERTION METHOD		SYRINGE	ACCESSORIES			QTY
	Ø FR.	LENGTH CM	Ø GA.	DESIGN	MATERIAL	LENGTH CM	Ø MM (INCH)	LENGTH MARKER	SELDINGER	CATHETER OVER NEEDLE ASSEMBLY		RAULERSON	SCALPEL	DRAPE 60X90	
CD-10802	8	11	14-14	E	PUR	45	0.46 (0.025")	x	x	18	5 ml – LS	x	x	1	5
CD-13902	9	13	14-14	E	PUR	60	0.46 (0.025")	x	x	18	5 ml – LS	x	x	1	5

ARTERIAL CATHETERISATION

Thanks to their patented integral wire design, our ARROW arterial catheterisation products help save time and increase the success rate of arterial access. Different types of arterial catheters are available using traditional Seldinger and modified Seldinger techniques, thus ensuring

reliable performance in paediatric applications as well. Our short-sized arterial catheterisation sets enable smooth needle placement and easy insertion. They are intended to reduce complications resulting from kinking and vessel trauma.

RADIAL ARTERY CATHETERISATION SETS

- smooth needle placement: low friction needle and improved bevel require less penetration force, resulting in better control of needle placement within the vessel
- shorter lengths for improved safety particularly suited for children
- improved guidewires with depth markings to optimise positioning on spring-wire guides (straight wires only)
- hydrophilic coatings ensuring smooth insertion
- improved kink-resistance is intended to reduce complications and vessel trauma
- low-profile, angled suture wings for improved patient comfort and optimal positioning
- integral extension sets to reduce potential clinician exposure to blood-borne pathogens

RADIAL ARTERY CATHETERISATION SET

- Seldinger technique
- integrated suture wings
- latex-free



SET COMPONENTS

- PUR catheter, 22 Ga. x 3.49 cm
- introducer needle TW, 21 Ga. x 3.81 cm
- spring-wire guide, 0.18" x 25 cm

REF.	QTY
GH-04122	25

RADIAL ARTERY CATHETERISATION SET

- modified Seldinger technique
- radiopaque



SET COMPONENTS

- catheter over needle, 22 Ga. x 3.49 cm
- introducer needle TW, 23 Ga.
- spring-wire guide, 0.015" x 12.4 cm, tube assembly

REF.	QTY
RA-04122	50

SELDINGER ARTERIAL CATHETER (SAC)

NEONATES

- Seldinger technique
- spring-wire guide with straight tip on both ends with insertion markings
- introducer needle is a 24 Ga. 1.9 cm catheter over a 26 Ga. needle
- 24 Ga. catheter with 7 cm integrated extension tubing and suture wing
- latex-free

PAEDIATRICS

- Seldinger technique
- spring-wire guide with straight tip on both ends with insertion markings
- catheter with 7 cm integrated extension tubing and suture wing
- sharper cutting bevel; requires less penetration force
- silicone heat treated; smoother insertion & better tactile feel
- matched gauge size for needle and catheter
- latex-free

SAC SETS FOR NEONATES

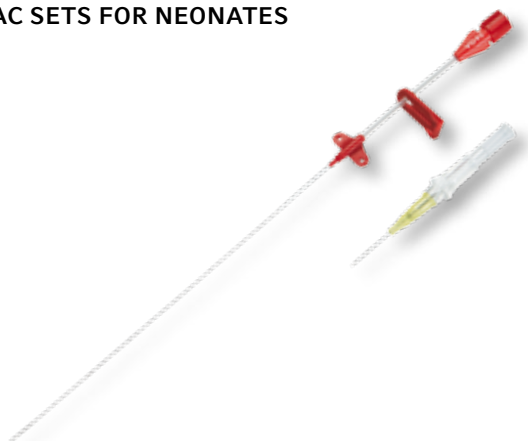

SET COMPONENTS

- introducer needle (catheter over needle technique)
- spring-wire guide
- indwelling catheter with low-profile suture wing and extension tube with slide clamp for blood containment

REF.	DESCRIPTION	NEEDLE SIZE	SWG SIZE	QTY
SAC-00324	24 Ga. x 2.5cm	24/26 Ga. x 1.9 cm	0.018" x 25 cm S	10
SAC-00524	24 Ga. x 5 cm	24/26 Ga. x 1.9 cm	0.018" x 25 cm S	10

SAC SETS FOR PAEDIATRICS

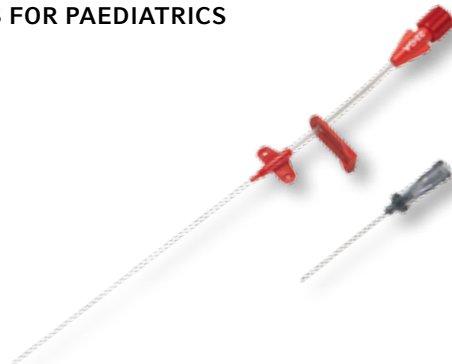

SET COMPONENTS

- introducer needle
- spring-wire guide
- indwelling catheter with low-profile suture wing and extension tube with slide clamp for blood containment

REF.	DESCRIPTION	NEEDLE SIZE	SWG SIZE	QTY
SAC-00522	22 Ga. x 5 cm	22 Ga. x 4 cm	0.021" x 35cm S	10
SAC-00822	22 Ga. x 8 cm	22 Ga. x 4 cm	0.021" x 35cm S	10
SAC-01222	22 Ga. x 12cm	22 Ga. x 4 cm	0.021" x 35cm S	10
SAC-00520	20 Ga. x 5 cm	20 Ga. x 4 cm	0.021" x 35cm S	10
SAC-00820	20 Ga. x 8 cm	20 Ga. x 4 cm	0.021" x 35cm S	10
SAC-01220	20 Ga. x 12cm	20 Ga. x 4 cm	0.021" x 35cm S	10

RIGHT HEART PRODUCTS

Teleflex's ARROW product range includes advanced percutaneous sheath introducer systems (PSI) for use in critical situations in operating theatres and paediatric ICUs, as well as matching thermodilution catheters, catheters for arterial pressure monitoring and Berman angiography catheters. These are complemented by short-sized introducer sets for venous and arterial access

using the tried and tested Seldinger technique. They enable smooth needle placement as well as easy insertion and reduce complications from kinking and vessel trauma. With a wide variety of choices and highly advanced systems, we can supply you with everything you need from one hand.

PERCUTANEOUS SHEATH INTRODUCERS

The flexible part of the introducer at the haemostasis valve prevents kinking issues when a pulmonary catheter is inserted and allows for accurate monitoring even with patient movement – a distinct benefit, particularly when monitoring children.

INTRODUCERS FOR PA & TD CATHETERS

Built-in infection protection (Cath-Gard Catheter Contamination Shield) to decrease costly complications

- easy insertion, reduced vessel trauma due to ultra-smooth PU which softens in situ
- simplified spring-wire guide placement
- minimised risk of air embolism or blood loss thanks to haemostasis valve and lock on obturator
- secure anchoring of sheath without restricting flow
- sheath virtually eliminates kinking due to exclusive coilwire design, thus enabling consistent and accurate monitoring
- extremely radiopaque for easy visualisation

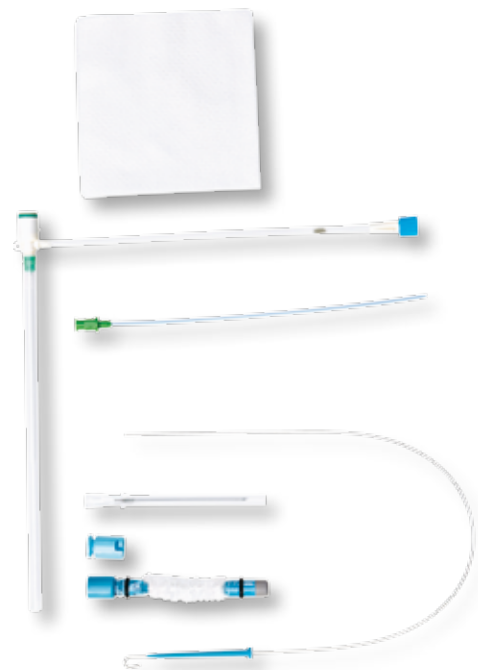

INTRODUCERS FOR PA & TD CATHETERS ARROW

REF.	SHEATH SIZE	SHEATH MATERIAL	Ø MM (INCH)	QTY
AK-09601	6 Fr.	PUR	0.035"	10
SI-09600	6 Fr.	PUR	0.035"	10

Attention:

These products contain natural rubber latex which may cause allergic reactions.

CATH LAB INTRODUCERS FOR PA & BERMAN CATHETERS

Percutaneous sheath introducer sets with integral haemostasis valve and side port

- outstanding kink resistance through use of polyurethane material
- reduced kinking at the hub with the special stress-relief hub sleeve
- reduced opportunity for peel-back or buckling because of thicker tip and heavy-walled design
- ease of use and added protection against blood contamination with exclusive Arrow Raulerson Syringe (CW-sets)
- wide variety of sheath sets and individual sheaths

CATH LAB INTRODUCERS FOR PA & BERMAN CATHETERS

ARROW

REF.	SHEATH SIZE	SHEATH LENGTH	COLOUR CODED HUB	QTY
CL-08403	4 Fr.	7.5 cm	pink	10
CP-08403	4 Fr.	7.5 cm	pink	10
CW-08403	4 Fr.	7.5 cm	pink	10
CL-08503	5 Fr.	7.5 cm	grey	10
CP-08503	5 Fr.	7.5 cm	grey	10
CW-08503	5 Fr.	7.5 cm	grey	10
CP-08603-P	6 Fr.	7.5 cm	green	10



SUPER ARROW-FLEX® INTRODUCERS FOR PA & TD CATHETERS

Super Arrow-Flex percutaneous introducer sets with integral haemostasis valve and side port

- complete vascular access, easy insertion and handling
- sheath and dilator lock together to enable simultaneous, secure insertion
- exclusive coil-wire design allows the sheath to flex at any point in any direction without kinking or losing support
- excellent steerability helps negotiate tortuous anatomies
- tapered dilator provides exceptional pushability to the contralateral leg and the superficial femoral artery (SFA)
- spring-wire guide (straight soft tip on one end, “J”-Tip on other)
- colour-coded



SUPER ARROW-FLEX INTRODUCERS

ARROW

REF.	SHEATH SIZE	SHEATH LENGTH	COLOUR CODED HUB	QTY
CP-07511-P	5 Fr.	7.5cm	grey	10
CP-07611-P	6 Fr.	7.5cm	green	10

THERMODILUTION CATHETERS

EASY INSERTION, HANDLING AND MANAGEMENT

- torque controlled catheters for better manoeuvrability and control even at femoral insertion site – retains firmness in situ for a longer time
- tapered tip for easy handling while inserting through sheath
- flow directed for easy positioning
- no step-up at balloon/catheter junction:
5 Fr allows equal sheath/catheter sizing if desired
- minimises potential for vessel trauma and blood loss
- larger distal lumen due to tapered tip design for better waveform visualisation
- simplified lumen identification with standard colour coding
- translucent polyurethane extension lines:
allows easy identification of air bubbles



SET COMPONENTS

- thermistor catheter
- control stroke syringe
- non-vented dust cap extension line clamps

THERMODILUTION CATHETERS CONVENTIONAL STYLE

ARROW

REF.	Ø FR.	USEFUL LENGTH	LUMEN	INTRODUCER SIZE (FR.) RECOMMENDED	MAXIMUM BALLOON CAPACITY	INFLATED BALLOON Ø	MAXIMUM WIRE FOR INSERTION (INCH)	CVC PROXIMAL LUMEN PORT DISTANCE FROM TIP	QTY
AI-07044	4	75 cm	4	5 Fr.	0.75 ml	8 mm	0.014"	10 cm	5
AI-07165	5	80 cm	4	5 or 6 Fr.	1.00 ml	8 mm	0.018"	15 cm	5

Attention: These products contain natural rubber latex which may cause allergic reactions.

BALLOON WEDGE-PRESSURE (PA) CATHETERS

SMOOTH AND FLEXIBLE

- unique tapered construction allows the catheter to be matched to the introducer size
- designed to provide a greater degree of torque control
- smooth flexible catheter body facilitates insertion
- flotation control allows blood flow to carry the inflated balloon naturally through the ventricle and into the pulmonary artery
- clear, easy to identify increment markings every 10 cm along the catheter body to confirm insertion depth
- catheter tip position may be determined by continuous pressure monitoring
- wide range of sizes and lengths for more accurate matching of patient needs
- packed in a sterile peel-pack tray with a control stroke syringe



SINGLE LUMEN BALLOON WEDGE-PRESSURE CATHETERS

ARROW

REF.	Ø FR.	INTRODUCER SIZE RECOM'D	USEFUL LENGTH	MAX. INFLATION* CAPACITY	INFLATED MAX. BALLOON Ø	MAX. WIRE RECOM'D	MAX. INJECTION FLOW RATE	MAX. INJECTION** PRESSURE	QTY
AI-07121	4	5 Fr.	60 cm	0.60 ml	6.5 mm	0.021"	n/a	n/a	5
AI-07122	4	5 Fr.	110 cm	0.60 ml	6.5 mm	0.021"	n/a	n/a	5
AI-07123	5	5 Fr.	60 cm	0.75 ml	8.0 mm	0.025"	n/a	n/a	5
AI-07124	5	5 Fr.	110 cm	0.75 ml	8.0 mm	0.025"	5 ml/sec	600 p.s.i.g.	5
AI-07125	6	6 Fr.	60 cm	1.00 ml	10.0 mm	0.035"	n/a	n/a	5
AI-07126	6	6 Fr.	110 cm	1.00 ml	10.0 mm	0.035"	6 ml/sec	600 p.s.i.g.	5
AI-07126-J	6	6 Fr.	90 cm	1.00 ml	10.0 mm	0.035"	n/a	n/a	5

Attention: These products contain natural rubber latex which may cause allergic reactions.

Double Lumen Balloon Wedge-Pressure catheters are available in two sizes, allowing determination of pressure gradients between adjacent parts of the heart as well as identifying a variety of congenital heart defects and obstructions.

DOUBLE LUMEN BALLOON WEDGE-PRESSURE CATHETERS

ARROW

REF.	Ø FR.	INTRODUCER SIZE RECOM'D	USEFUL LENGTH	MAX. INFLATION* CAPACITY	INFLATED BALLOON Ø	MAX. WIRE RECOM'D	EXIT PORT SPACING	QTY
AI-07025	5	5 Fr.	80 cm	1.00 ml	8.0 mm	0.018"	proximal port exits 3 cm from tip	5
AI-07026	6	6 Fr.	110 cm	1.00 ml	10.0 mm	0.021"	proximal port exits 3 cm from tip	5

Attention: These products contain natural rubber latex which may cause allergic reactions.

* CO₂ is the recommended inflation media. See instructions for use prior to using air. Do not use any liquid to inflate the balloon.

** Measured using Renografin 76 (T.M.E.R. Squibb Co.) with 2 second injection time.

ARROW-BERMAN™ ANGIOGRAPHIC CATHETER

THE ONLY ORIGINAL PROVEN DESIGN

- higher flow and fewer complications, greater control and better manipulation
- available in two configurations, standard and reverse Berman (i.e BOFA for ipsilateral approach or pulmonary angiography) and in a wide range of French catheter sizes to meet different clinical needs
- smooth flexible catheter body facilitates insertion and positioning
- unique tapered-tip construction ensures that the diameter of the deflated balloon does not exceed the diameter of the catheter body, facilitating percutaneous insertion by sheath matched to catheter size and reducing blood loss
- flotation control allows blood flow to carry the inflated balloon naturally through the ventricle and into the pulmonary artery
- clear and easy to identify increment markings every 10 cm to confirm insertion depth
- catheter tip position may be determined by continuous pressure monitoring
- allows injection of contrast media at the front or the back of the balloon for different techniques
- junction hub and extension line design offer higher flow rates and injections
- injectate outflow design optimises dye distribution and minimises risk of arrhythmias and myocardial staining by directing dye away from the myocardial wall
- appropriately sized syringe with stop helps reduce balloon overinflation
- easy identification by colour-coded injectate port (pink for standard and blue for reverse Berman)
- packed in a sterile peel-pack tray



ARROW-BERMAN ANGIOGRAPHIC CATHETERS FOR BALLOON OCCLUSION ANGIOGRAPHY (BOFA)

ARROW

REF.	Ø FR.	INTRODUCER SIZE RECOM'D	USEFUL LENGTH RECOMMENDED	MAX. INFLATION CAPACITY	INFLATED MAXIMUM BALLOON Ø	MAX. WIRE RECOM'D	IMPROVED MAX. INJ. FLOW RATE	MAX. INJECTION PRESSURE	QTY
AI-07134	4	5 Fr.	50 cm	0.60 ml	6.5 mm	0.021"	6 ml/sec	600 p.s.i.g.	5
AI-07130	5	5 or 6 Fr.	50 cm	0.75 ml	8.0 mm	0.032"	15 ml/sec	540 p.s.i.g.	5
AI-07130-J	5	5 or 6 Fr.	60 cm	0.75 ml	8.0 mm	0.032"	15 ml/sec	540 p.s.i.g.	5
AI-07135	5	5 or 6 Fr.	80 cm	0.75 ml	8.0 mm	0.032"	12 ml/sec	540 p.s.i.g.	5
AI-07131	6	6 or 7 Fr.	60 cm	1.00 ml	10.0 mm	0.035"	20 ml/sec	650 p.s.i.g.	5
AI-07136	6	6 or 7 Fr.	90 cm	1.00 ml	10.0 mm	0.035"	18 ml/sec	650 p.s.i.g.	5

REVERSE ARROW-BERMAN CATHETER FOR SELECTIVE PULMONARY OCCLUSION ANGIOGRAPHY STUDIES

ARROW

REF.	Ø FR.	INTRODUCER SIZE RECOM'D	USEFUL LENGTH RECOMMENDED	MAX. INFLATION CAPACITY	INFLATED BALLOON Ø	MAX. WIRE RECOM'D	IMPROVED MAX. INJ. FLOW RATE	MAX. INJECTION PRESSURE	QTY
AI-07035	5	5 or 6 Fr.	80 cm	1.25 ml	12.0 mm	0.032"	8 ml/sec	600 p.s.i.g.	5

Attention: These products contain natural rubber latex which may cause allergic reactions.



FILTRATION & HUMIDIFICATION

Teleflex's extensive line of products for humidification and filtration purposes includes everything from active to passive humidification, from combined heat and moisture exchangers to a variety of bacterial/viral filters. Without effective protection, patients run a greater risk of cross-contamination leading to nosocomial infections. This is precisely where we come in.

ACTIVE HUMIDIFICATION

HUDSON RCI products for active humidification feature our versatile ConchaTherm Neptune Heated Humidifier, which is accompanied by the Conchapak self-contained water system, a column and a variety of reservoirs, and complemented by a paediatric Dual-Thermistor probe.

A choice of neonatal heated-wire ventilator circuits specifically designed for use with the ConchaTherm Neptune adds to the system's user-friendliness. We provide you with everything you need for safe and efficient usage in the paediatric ward.

CONCHATHERM NEPTUNE™ HEATED HUMIDIFIER

The ConchaTherm Neptune Heated Humidifier offers the utmost in simplicity while allowing the clinician to make adjustments and customise settings. From responding to unique patient or environmental challenges to keeping up with hospital protocols, the ConchaTherm Neptune Heated Humidifier is versatile enough to handle all needs.

The Neptune is designed to heat and humidify respiratory gases for patients of all ages and across the full spectrum of therapeutic applications: Invasive ventilation, non-invasive ventilation, oxygen hoods and high-flow nasal cannula therapy. Neptune utilises the time-tested and handy Concha-Column and prefilled sterile water reservoir system that supports both conventional and heated-wire circuits. To assure that therapeutic humidity levels can be achieved, the Neptune is also equipped with a unique "hot gas" mode, specifically for use with today's high outlet ventilator temperatures.

Simplicity, versatility and unparalleled performance.



- ease of use with plug and play operation
- invasive and non-invasive modes
- compatible with heated-wire and non-heated wire circuits
- adjustable gradient control, pause time and patient airway temperature
- low humidity advisory
- hot gas mode
- automatic detection of circuit type (adult, paediatric, infant)
- 24V system offers superior condensation control

CONCHATHERM NEPTUNE		HUDSON RCI
REF.	DESCRIPTION	QTY
425-10	230 V, 50 Hz European style power plug	1
425-30	United Kingdom style power plug	1
395-99	Dual-Thermistor probe to use with ConchaTherm Neptune <ul style="list-style-type: none"> • length 210 cm • straight-tip proximal probe 	1

CONCHAPAK® SYSTEM

SELF-CONTAINED WATER SYSTEM FOR USE WITH CONCHATHERM HEATERS

- safe, reliable gravity-feed system provides uninterrupted water flow
- easy reservoir and column replacement

CONCHAPAK *HUDSON RCI*

REF.	VOLUME	DESCRIPTION	QTY
438520	1650 ml	<ul style="list-style-type: none"> • low-compliance Concha-Column with Concha sterile water reservoir • right-angle port 	6

CONCHA STERILE WATER RESERVOIRS *HUDSON RCI*

REF.	VOLUME	DESCRIPTION	QTY
438150	1650 ml	Concha reservoir	6
438151	440 ml	Concha Mini reservoir	20
438152	760 ml	Concha Mini reservoir	10

LOW-COMPLIANCE COLUMN *HUDSON RCI*

REF.	DESCRIPTION	QTY
438220	<ul style="list-style-type: none"> • for use in most applications requiring more constant compressible volume and compliance or CPAP applications with continuous gas flow less than 50 LPM • compressible volume: 248 ml ± 12 ml • compliance: 0.25 ml cm H₂O 	24



NEONATAL HEATED-WIRE VENTILATOR CIRCUITS

Specially designed for use with Teleflex's ConchaTherm Neptune heated humidification system, the HUDSON RCI heated-wire neonatal circuits include adaptors necessary for maximum set-up versatility.

A conventional neonatal circuit is also available (see Catheter Mounts). Constructed of lightweight, drapable polyethylene tubing, HUDSON RCI neonatal circuits are 120 cm long and individually packed.

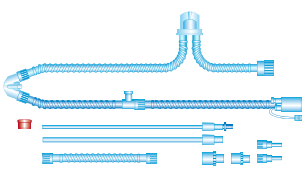
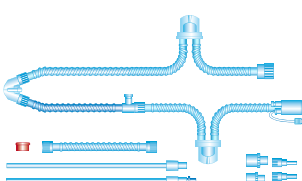
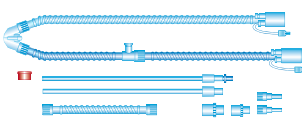
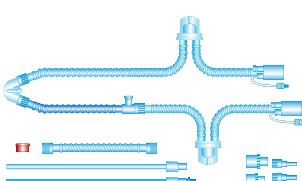
NEONATAL VENTILATOR CIRCUITS MADE OF POLYETHYLENE				HUDSON RCI	
	REF.	DESCRIPTION	LENGTH	QTY	
	780-13	<ul style="list-style-type: none"> • single 21-volt heated-limb circuit • 45 cm remote temperature port • expiratory limb water trap • humidifier line • single use 	120 cm	20	
	780-14	<ul style="list-style-type: none"> • single 21-volt heated-limb circuit • 45 cm remote temperature port • inspiratory and expiratory limb water traps • humidifier line • single use 	120 cm	20	
	780-07	<ul style="list-style-type: none"> • dual 21-volt heated-limb circuit • 45 cm remote temperature port • humidifier line • single use 	120 cm	20	
	780-15	<ul style="list-style-type: none"> • 21-volt dual heated limb circuit • 45 cm remote temperature port • inspiratory and expiratory limb water traps • humidifier line • single use 	120 cm	20	

PASSIVE HUMIDIFICATION

Teleflex manufactures several choice products for passive humidification and filtration in paediatric care. The GIBECK Heat & Moisture Exchangers and bacterial/viral filters offer a wide range of performance capabilities and configuration options to meet the unique needs of anaesthesia, intensive care, emergency care and ENT

in the paediatric ward. These products are characterised by optimal moisture output coupled with low resistance to flow, cross-contamination protection thanks to outstanding filtration efficiency, low dead-space and light weight.

HUMID-VENT® FAMILY

HUMID-VENT MICRO+

- especially designed for neonatal care
- connects directly and replaces the ET-tube connector
- fitted to use on 3.0 or 3.5 mm endotracheal tube
- port allows easy access for suctioning, installation of surfactants and CO₂ sampling
- provides “negative” deadspace
- latex-, phthalate- & PVC-free
- sterile
- single use
- individually packed



HUMID-VENT MICRO+							Gibeck	
REF.	DESCRIPTION	TV RANGE	MOISTURE OUTPUT (MG H ₂ O/L)	WEIGHT	RESISTANCE (CM H ₂ O)	DEAD SPACE	QTY	
10121	Humid-Vent Micro+ 3.0	10 – 50 ml	32mg / Vt 20	4.3 g	1.8, 5 LPM	2.7 ml	10	
10131	Humid-Vent Micro+ 3.5	10 – 50 ml	32mg / Vt 20	4.3 g	1.1, 5 LPM	2.7 ml	10	

HUMID-VENT MINI

- designed specifically for neonates and babies
- standard 15 mm connector
- latex-, phthalate- & PVC-free
- sterile or clean
- single use
- individually packed



HUMID-VENT MINI							Gibeck	
REF.	DESCRIPTION	TV RANGE	MOISTURE OUTPUT (MG H ₂ O/L)	WEIGHT	RESISTANCE (CM H ₂ O)	DEAD SPACE	QTY	
10011	sterile	15 – 50 ml	30mg / Vt 20	4.5 g	0.6, 5 LPM	2.4 ml	30	
10012	clean	15 – 50 ml	30mg / Vt 20	4.5 g	0.6, 5 LPM	2.4 ml	30	

HUMID-VENT 1

The original Humid-Vent 1 has been used in hospitals worldwide for over 25 years. It is available straight, with or without CO₂ port. The Humid-Vent 1 is recommended for use with adults and children in anaesthesia as well as with children in the ICU.

- with original hygroscopic corrugated HME media
- latex-, phthalate- & PVC-free
- sterile or clean
- single use
- individually packed



HUMID-VENT 1							Gibeck	
REF.	DESCRIPTION	TV RANGE	MOISTURE OUTPUT (MG H ₂ O/L)	WEIGHT	RESISTANCE (CM H ₂ O)	DEAD SPACE	QTY	
11111	sterile	50 – 600 ml	29mg / Vt 300	9.4 g	0.3, 20 LPM	10 ml	50	
11112	clean	50 – 600 ml	29mg / Vt 300	9.4 g	0.3, 20 LPM	10 ml	50	
11132	with port, clean	50 – 600 ml	29mg / Vt 300	11.6 g	0.3, 20 LPM	14 ml	25	

TRACH-VENT® FAMILY

Our GIBECK Trach-Vent has been in clinical use for more than 30 years. The Trach-Vent and Trach-Vent+ light-weight HMEs (Heat and Moisture Exchanger) are synonymous with excellent humidification and are especially developed for spontaneously breathing tracheostomised patients. With their small, discreet design and low dead space of only 10 ml, these products can be used for adults and children in ICU, ENT as well as in the home care environment.

TRACH-VENT+

With its new universal and unique oxygen connector, the Trach-Vent+ is now compatible with all available oxygen tubings in the market.

- small, compact
- lightweight
- low dead space
- easy to handle
- ISO standard connectors
- latex-, phthalate- & PVC-free
- single use



TRACH-VENT+ AND OXY TUBE

Convenient set for immediate use, not mounted

- 1 Trach-Vent+
- 1 Oxy-Tube

REF.	QTY
41322	10



TRACH-VENT+								Gibeck	
REF.	DESCRIPTION	TV RANGE	MOISTURE OUTPUT (MG H ₂ O/L)	WEIGHT	RESISTANCE (CM H ₂ O)	DEAD SPACE	CO ₂ CONNECTOR	QTY	
41311U	sterile	> 50	29.2mg / Vt 500	6.3 g	0.25, 30 LPM	10 ml	universal connector	50	
41312U	clean	> 50	29.2mg / Vt 500	6.3 g	0.25, 30 LPM	10 ml	universal connector	50	

TRACH-VENT

- the original “Swedish Nose”
- small, compact; low dead space
- lightweight
- ISO standard connector
- latex-, phthalate- & PVC-free
- single use



TRACH-VENT STARTER KIT

A comprehensive system for use in ICU, home care and long-term care applications.

- 3 Trach-Vents
- 1 Trach-Vent holder
- 1 Oxy-Vent with tubing
- individually packed



REF.	QTY
41172	6



TRACH-VENT

Gibeck

REF.	DESCRIPTION	TV RANGE	MOISTURE OUTPUT (MG H ₂ O/L)	WEIGHT	RESISTANCE (CM H ₂ O)	DEAD SPACE	CO ₂ CONNECTOR	QTY
41111	sterile	> 50 ml	29.2mg / Vt 500	4 g	0.25, 30 LPM	10 ml	universal connector with Oxy-Vent	50
41112	clean	> 50 ml	29.2mg / Vt 500	4 g	0.25, 30 LPM	10 ml	universal connector with Oxy-Vent	50

OXY-VENT

Gibeck

	REF.	DESCRIPTION	QTY
	49912	Oxy-Vent without tubing <ul style="list-style-type: none"> • for the delivery of humidified supplemental oxygen • with simple snap-on adaptor • for easy oxygen supply • individually packed 	20
	45512	Oxy-Vent with tubing <ul style="list-style-type: none"> • for the delivery of humidified supplemental oxygen • with simple snap-on adaptor • for easy oxygen supply • individually packed 	10

TRACH-VENT HOLDER

Gibeck

	REF.	DESCRIPTION	QTY
	61112	Conveniently attaches the Trach-Vent to the tracheostomy or endotracheal tube, so that the Trach-Vent can be easily replaced during suctioning or change. <ul style="list-style-type: none"> • easy handling • individually packed 	30

AQUA+ TS

A HME for spontaneously breathing patients with incorporated port for oxygen supply and self closing valve for suctioning. Ideal for children with tidal volumes of 75 ml and up.

- for use with tracheostomy tubes with 15mm O.D. connector
- port for supplemental oxygen
- port for suctioning
- safety valve
- latex-, phthalate- & PVC-free
- clean
- single use



AQUA+ TS

Gibeck

REF.	DESCRIPTION	TV RANGE	MOISTURE OUTPUT (MG H ₂ O/L)	RESISTANCE (CM H ₂ O)	DEAD SPACE	QTY
41574	clean	75-1000 ml	24mg / Vt 0.5l	0.2, 60 LPM	15 ml	30

COMBINED HMEF

GIBECK Humid-Vent filter products unite a Heat and Moisture Exchanger (HME) with a hydrophobic bacterial/viral filter and thus offer solutions to meet the needs of both anaesthesia and intensive care. They are the optimal product for children as they reduce the risk of cross-contamination. The Humid-Vent Filter Small can be used

for adult and paediatric applications, as well as for short- and long-term use. The Humid-Vent Filter Pedi has been especially developed for children. With its compact and lightweight design it provides excellent heat and humidification output combined with very low deadspace.

HUMID-VENT® FILTER FAMILY

The Humid-Vent product family was developed from the true original passive humidifier, called the “Swedish nose”, which was invented by GIBECK over 30 years ago. HMEFs can be fitted patient close, both in the ICU and in anaesthesia, and are available in different sizes and designs, thus optimising their application possibilities. HMEFs provide outstanding filtration performance and humidification properties, similar to the ISO standard for active humidifiers.

- lightweight
- very low dead space
- low resistance to flow
- latex-, phthalate- & PVC-free
- clean or sterile
- single use
- individually packed



Humid-Vent Filter Pedi

Humid-Vent Filter Small

HUMID-VENT FILTER PEDI

Gibeck

REF.	DESCRIPTION	FILTER EFFICIENCY %	TV RANGE	MOISTURE LOSS (MG H ₂ O/L)	MOISTURE OUTPUT (MG H ₂ O/L)	WEIGHT	RESISTANCE (CM H ₂ O)	DEAD SPACE	QTY
11011	angled, sterile	>99.9999 (bacteria) >99.99 (virus)	50 – 250 ml	6 mg / Vt 250	33 mg / Vt 50 30 mg / Vt 100 30 mg / Vt 250	14.5 g	1.4, 20 LPM	13 ml	20
11012	angled, clean		50 – 250 ml	6 mg / Vt 250		14.5 g			
12011	straight, sterile		50 – 250 ml	6 mg / Vt 250	13.5 g				
12012	straight, clean		50 – 250 ml	6 mg / Vt 250	13.5 g				

HUMID-VENT FILTER SMALL

Gibeck

REF.	DESCRIPTION	FILTER EFFICIENCY %	TV RANGE	MOISTURE LOSS (MG H ₂ O/L)	MOISTURE OUTPUT (MG H ₂ O/L)	WEIGHT	RESISTANCE (CM H ₂ O)	DEAD SPACE	QTY
18501	angled, sterile	>99.9999 (bacteria) >99.999 (virus)	150 – 1000 ml	6 mg / Vt 250	31mg / Vt 250 30mg / Vt 500 29mg / Vt 750	22.0 g	2.1, 30 LPM	27 ml	20
18502	angled, clean		150 – 1000 ml	7 mg / Vt 500		22.0 g			
19501	straight, sterile		150 – 1000 ml	8 mg / Vt 750	21.0 g				
19502	straight, clean		150 – 1000 ml		21.0 g				

BACTERIAL/VIRAL FILTERS

Teleflex’s advanced GIBECK bacterial/viral filters offer excellent protection and performance. They have been independently tested (in several laboratories around the world) and proven to be highly efficient in preventing the passage of bacteria and viruses, without being affected

by humidity and/or anaesthetic gases. The lightweight Iso-Gard Filter Small is designed for adults and children and is ideal for close fitting. The hydrophobic HEPA Small is ideal in cases of small tidal volumes in ICUs and low flow anaesthesia.

ISO-GARD® FILTER FAMILY

ISO-GARD HEPA SMALL

This hydrophobic bacterial/viral HEPA filter with HME properties offers maximum filtration efficiency and protection of patients, personnel and breathing equipment.

- HEPA classification 13
- single connectors ISO standard 15/22-15 mm
- latex-, phthalate- & PVC-free
- clean or sterile
- single use
- individually packed



ISO-GARD HEPA SMALL

Gibeck

REF.	DESCRIPTION	FILTER EFFICIENCY %	MOISTURE OUTPUT (MG H ₂ O/L)	WEIGHT	RESISTANCE (CM H ₂ O)	DEAD SPACE	QTY
28051	angled, sterile	Filtration efficiency >99.9999 (bacteria) >99.9999 (virus) >99.999 (mycobacterium tuberculosis)	25 mg / Vt 250 20 mg / Vt 500	16 g	2.3, 30 LPM	31 ml	25
28052	angled, clean			16 g			
28061	straight, sterile			15 g			
28062	straight, clean			15 g			

ISO-GARD FILTER SMALL

Designed for adults and children, our GIBECK Iso-Gard Filter Small ensures maximum protection from contamination to patient, equipment and staff. It consists of electrostatic filtration media based on well known and thoroughly tested technology.

- small
- lightweight
- minimal dead space
- incorporated CO₂ port for gas sampling
- single connectors ISO standard 15/22 – 15 mm
- latex-, phthalate- & PVC-free
- clean or sterile
- single use
- individually packed



ISO-GARD SMALL

Gibeck

REF.	DESCRIPTION	FILTRATION EFFICIENCY %	WEIGHT	RESISTANCE (CM H ₂ O)	DEAD SPACE	QTY
18511	angled, sterile	Filtration efficiency >99.9999 (bacteria) >99.999 (virus)	16.0 g	1.9, 30 LPM	21 ml	20
18512	angled, clean		16.0 g			
19511	straight, sterile		15.0 g			
19512	straight, clean		15.0 g			



THORAX DRAINAGE SYSTEMS

Teleflex's Sahara chest drainage systems represent a selection of safe and easy to set up products for paediatric applications. Both drainage performance and patient protection have been maximised to ensure optimum outcomes. The systems provide all the safety aspects of one-way valve technology coupled with the diagnostic advantages you have come to expect from PLEUR-EVAC.

A-8000 SERIES – WET SUCTION / WET SEAL

Traditional chest drainage units, such as the PLEUR-EVAC A-8000 series, regulate the amount of suction via the height of a column of water in the suction control chamber. The PLEUR-EVAC wet suction series has been the industry standard since its introduction in 1967. Wet suction models are safe and accurate.

- **WATER-CONTROLLED SUCTION COLUMNS**
provide safe suction levels
- **HIGH NEGATIVITY FLOAT VALVE**
prevents loss of water seal
- **HIGH NEGATIVITY RELIEF VALVE**
permits manual filtered venting of excessive negative pressure



A-8000			PLEUR-EVAC
REF.	COLLECTION CHAMBER	APPLICATION	QTY
A-8020-08LF	200 ml	0–2 years	6

A-6000 SERIES – DRY SUCTION / WET SEAL

The patented PLEUR-EVAC A-6000 series is a clear choice for convenient, flexible, and safe chest drainage. The suction control feature functions as a true regulator: whenever fluctuations occur in source suction or air flow from a patient leak, the desired imposed suction level is automatically maintained without the need for clinical intervention. Set-up is quick and easy with no need to fill the suction chamber.

- **HIGH NEGATIVITY RELIEF CHAMBER**
prevents excessive negative pressure build-up
- **HIGH NEGATIVITY RELIEF VALVE**
permits manual filtered venting of excessive negative pressure
- **NEEDLELESS TUBING CONNECTORS**
for collection sampling



A-6000		PLEUR-EVAC	
REF.	COLLECTION CHAMBER	APPLICATION	QTY
A-6020-08LF	200 ml	0–2 years	6

SAHARA – DRY SUCTION / DRY SEAL

Our Sahara dry suction system stands for optimum drainage performance coupled with excellent patient protection. Patient air can exit through a valve which opens automatically on expiration and then immediately closes again to prevent atmospheric air from entering during inspiration. Thanks to this safe system there is no need to add any liquid for sealing purposes.

- **APPLICATION WITHOUT WATER**
no noise development, ready for immediate use
- **PATIENT PROTECTION**
integrated one-way valve against reflux – completely reliable, even when unit tips over
- **EXCELLENT SUCTION PERFORMANCE**
constant suction level, variable between -10 cm and -40 cm H₂O
- **DIAGNOSTICS**
optional filling of the air leak meter with water makes it possible to quantify air leaks for pneumothorax diagnosis
- **SAMPLING/ATS OPTION**
locking autotransfusion connectors with self-sealing port for direct collection sampling (without needle)
- **SAFETY**
compensation of major air leaks and fluctuations in negative pressure



SAHARA		PLEUR-EVAC	
REF.	COLLECTION CHAMBER	APPLICATION	QTY
S-1130-08LF	200 ml	children 2 years and up	4



OXYGEN & AEROSOL THERAPY

Featuring the broadest selection of masks, cannulas, tubing and humidifiers in the industry, Teleflex can help you manage the respiratory needs of your patients, while keeping an eye on quality, efficiency and cost.

Built on a solid tradition of innovation, HUDSON RCI aerosol delivery products are in a class of their own. We make it our priority to improve patient outcomes by always using the latest technological improvements. And where children's well-being is concerned, we double our efforts.

MASKS / NASAL CANNULAS

We make a large range of oxygen masks offering a maximum of comfort for children: Adjustable noseclips assure a comfortable fit and clear, soft vinyl enables visual patient assessment. The under-the-chin-design of our elongated aerosol mask provides an excellent fit for a wide variety of faces, and thanks to a special manufacturing process, our

paediatric nasal cannulas for chronic and acute patient care are exceptionally soft. The popular over-the-ear design also helps provide a comfortable and secure fit. Having set the industry standard for decades, it is not only lightweight and flexible but also cost-effective.

SEE-THRU® MASK

OXYGEN MASK

- medium concentration
- clear, soft vinyl
- unsterile
- single use
- individually packed

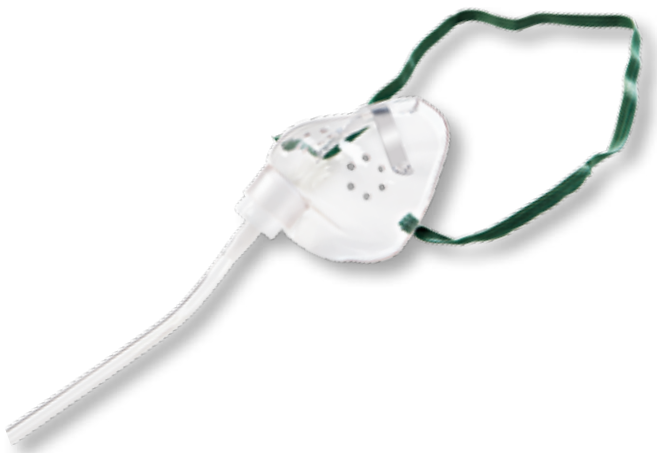

SEE-THRU MASK *HUDSON RCI*

SEE-THRU ELONGATED MASK *HUDSON RCI*

REF.	DESCRIPTION	QTY
41035	with 210 cm oxygen supply tubing	50

REF.	DESCRIPTION	QTY
41042	with 210 cm oxygen supply tubing	50
41050	without oxygen supply tubing	50

NONREBREATHING MASK WITH SAFETY VENT

OXYGEN MASK (HALF OPEN)

- clear, soft vinyl
- low-resistance check valve prevents rebreathing and allows exhaled gas to escape
- safety vent allows for entrainment of room air and application of high oxygen rates
- complete with 210 cm of oxygen supply tubing
- unsterile
- single use
- individually packed



NONREBREATHING MASK		HUDSON RCI
REF.	QTY	
41058	50	

MULTI-VENT® MASK

AIR ENTRAINMENT

- colour-coded, air-entrainment low- and medium-concentration diluters
- Venturi system
- locking ring secures flow setting
- includes adaptor for high humidity
- complete with 210 cm of oxygen supply tubing
- unsterile
- single use
- individually packed

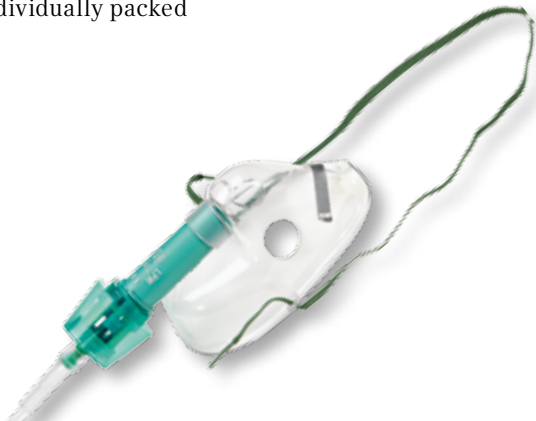

MULTI-VENT MASK		HUDSON RCI
REF.	QTY	
41089	50	



Low-Concentration Diluter (green) for 24 %, 26 %, 28 % and 30 %

Medium-Concentration Diluter (white) for 35 %, 40 % and 50 %

MULTI-VENT – TOTAL GAS FLOW TO PATIENT*

OXYGEN % SETTING	SUGGESTED OXYGEN FLOW	TOTAL GAS FLOW
24 %	3 LPM	79 LPM
26 %	3 LPM	47 LPM
28 %	6 LPM	68 LPM
30 %	6 LPM	53 LPM
35 %	9 LPM	50 LPM
40 %	12 LPM	50 LPM
50 %	15 LPM	41 LPM

* at specific diluter and flow settings

SOFTECH® NASAL CANNULA

- extremely soft, light-weight and flexible
- anatomic design enhances patient acceptance and comfort
- over-the-ear style optimises fit and stability
- with kink- and crush-resistant Star-Lumen tubing
- tubing 210 cm long
- unsterile
- single use



SOFTECH NASAL CANNULA

HUDSON RCI

REF.	ORDER SIZE	TUBING CONNECTOR	QTY
41826	Paediatric	universal hose end connector eliminates need for nipple-and-nut adaptors	50
41828	Infant	standard	50

ELONGATED AEROSOL MASK

- specifically designed for aerosol therapy
- clear, soft vinyl
- connector accepts 22 mm aerosol tubing
- with elongated under-the-chin-fit
- unsterile
- single use
- individually packed



ELONGATED AEROSOL MASK

HUDSON RCI

REF.	QTY
41085	50

TRACHEOSTOMY MASK

- for tracheostomy and laryngectomy aerosol therapy
- tubing connector swivels 360° and accepts 22 mm I.D. corrugated tubing
- unsterile
- single use
- individually packed



TRACHEOSTOMY MASK

HUDSON RCI

REF.	ORDER SIZE	QTY
41076	3	50

PREFILLED HUMIDIFIERS / NEBULISERS

Teleflex's prefilled humidification and nebulisation products optimally address the paediatric patient's needs. They provide efficient and safe systems for active humidification. Aquapak prefilled humidifiers combine an easy-to-use adaptor with a choice of sterile water reservoir bottles for inhalation.

They also provide versatile, sterile systems for cold or heated nebulisation. A variety of reservoirs, adaptors and solutions helps meet the specific requirements of your small patients. Coming from one source, our high-quality products can save you time and money.

AQUAPAK® PREFILLED HUMIDIFIERS OXYGEN THERAPY

The Aquapak prefilled humidifier systems equip you with a reliable tool for oxygen therapy. The easy-to-use humidifier adaptor incorporates an audible alarm that alerts the clinician to flow restriction or occlusion of the humidifier or oxygen tubing. The reservoir bottles have a built-in oxygen tubing connector with an easy snap-off trigger design.

A micro-diffuser, moulded into the reservoir bottle, produces smaller bubbles and increases surface area agitation allowing for noise-free humidification. HUDSON RCI Aquapak prefilled humidifiers provide performance, safety and value.

AQUAPAK HUMIDIFIER ADAPTOR

HUDSON RCI

	REF.	DESCRIPTION	QTY
	400040	<ul style="list-style-type: none"> • clear adaptor body for use with Ref. 400301 or 400601 • pressure relief valve 350-700 cm H₂O • audible pop-off • sterile • single use • individually packed 	120

AQUAPAK STERILE WATER

HUDSON RCI

	REF.	VOLUME	DESCRIPTION	QTY
	400601	650 ml	<ul style="list-style-type: none"> • water reservoir bottle only • for use with Ref. 400040 Humidifier Adaptor • sterile • single use • individually packed 	10
	400301	340 ml		20

AQUAPAK PREFILLED HUMIDIFIER

HUDSON RCI

	REF.	VOLUME	DESCRIPTION	QTY
	400640	650 ml	<ul style="list-style-type: none"> • includes sterile Humidifier Adaptor Ref. 400040 • reservoir bottle with built-in oxygen tubing connector and easy snap-off trigger design • single use • individually packed 	10
	400340	340 ml		20

AQUAPAK® PREFILLED NEBULISERS



AEROSOL THERAPY

Efficient and economic systems for cold or heated nebulisation: the two precision nebuliser adaptors you can choose from will deliver a consistent aerosol over a wide range of oxygen concentrations. The Aquatherm III heater for heated

aerosol treatment makes humidification more comfortable. Prefilled sterile reservoirs are available in three convenient sizes.

AQUAPAK NEBULISER ADAPTOR

HUDSON RCI

	REF.	DESCRIPTION	QTY
	403128	Nebuliser Adaptor 028 <ul style="list-style-type: none"> • Venturi-style entrainment ring allows the selection of oxygen concentrations from 28% to 98% • sterile • single use • individually packed 	50
	403133	Nebuliser Adaptor 033 <ul style="list-style-type: none"> • quiet adaptor allows the selection of oxygen concentrations from 33% to 98% to meet the needs of the ICU patient • sterile • single use • individually packed 	50

AQUAPAK STERILE WATER

HUDSON RCI

	REF.	VOLUME	DESCRIPTION	QTY
	404000	1070 ml	<ul style="list-style-type: none"> • water reservoir only • sterile • single use • individually packed 	10
	403700	760 ml		10
	400400	440 ml		20

AQUAPAK RESERVOIRS AND ADAPTORS

HUDSON RCI

	REF.	VOLUME	DESCRIPTION	QTY
	404128	1070 ml	<ul style="list-style-type: none"> • water reservoir • Nebuliser Adaptor 028 • sterile • single use 	10
	403728	760 ml		20
	404428	440 ml		10

AQUATHERM III® EXTERNAL ADJUSTABLE ELECTRONIC HEATER



- attaches onto the nebuliser system to provide heated aerosol
- adjustable aerosol temperature to meet patient needs with a sensitive temperature controller
- robust, durable heater
- 220 – 240 V, 50 Hz
- sold individually
- single patient use

REF.	QTY
050-12D	1

SMALL VOLUME NEBULISERS

When it comes to care for children, only the best is good enough. Our small volume nebulisers are designed to deliver superior and economic aerosol performance. They also humidify dry inspired gases, and improve mobilisation and the clearance of respiratory secretions.

Since they require neither a high breathing rate nor hand-breathing coordination, they can be used by infants in acute respiratory distress. Single-dose containers are designed to eliminate the risk of bacterial contamination. They are easy to use, save time and help to control costs.

MICRO MIST®

MEDICAL AEROSOL THERAPY

Our Micro Mist small volume nebuliser can be used for hand-held or in-line treatments. It produces a fine, dense mist at angles up to 90°. This allows the clinician to administer medications to patients with special treatment requirements such as those who are positioned horizontally.

Optimal particle size, efficient nebulisation rates and minimal residuals can be achieved.

An easy-seal, threaded cap and 6 ml capacity anti-spill jar prevent leakage and ensure easy assembly/disassembly. With paediatric mask Ref. 41085, also available separately.

- with nebuliser
- 210 cm long tubing
- standard 22 m tubing connector
- unsterile
- single use
- individually packed



Ref. 41894



Ref. 41892

MICRO MIST		HUDSON RCI
REF.	DESCRIPTION	QTY
41894	with paediatric mask	50
41892	with tee & mouth piece	50

UP-DRAFT® II

MEDICAL AEROSOL THERAPY

The compact, high output Up-Draft II produces a concentrated mist at flow rates of 5–9 LPM. It nebulises at angles up to 45° to accommodate special treatment requirements. An easy-seal, threaded cap and 8 ml capacity scalloped skirt anti-spill jar prevent leakage and ensure easy assembly/disassembly. The Up-Draft II offers exceptional mist, therapeutic particle size and efficient nebulisation times. With paediatric mask Ref. 41085, also available separately.

- with nebuliser
- tubing 210 cm long
- standard 22 mm tubing connector
- unsterile
- single use
- individually packed



Ref. 41707



Ref. 41732

UP-DRAFT II

HUDSON RCI

REF.	DESCRIPTION	QTY
41707	with paediatric mask	50
41732	with tee & mouth piece	50



TRACHEOSTOMY

Tracheostomy is a lifesaver for many infants and children who need airway support. Performing a tracheostomy in a child is more difficult than in an adult due to anatomical differences which make the child's airway more vulnerable. Therefore, tracheostomy tubes for paediatrics must be anatomically designed and manufactured with particular care. Well thought-out ranges of specially developed tubes mean we can provide the optimal tube for any application. With our years of experience in the development of "small" tubes, the Teleflex rÜSCH brand helps to make tracheostomy as tolerable and safe as possible for children.

ARMoured TRACHEOSTOMY TUBES

Offering mobility and flexibility where it is most badly needed, Teleflex's RÜSCH TracheoFlex sets provide you with a range of tubes for acute use in the ENT area and intensive therapy that are extremely soft, highly flexible and adaptable. The armoring renders the tubes very stable and kink-resistant. The short connector side of our TracheoFlex S sets makes the tube discreet and comfortable, meeting the needs of mobile young tracheostomy patients. Thanks to our latest TracFlex Plus inner cannula system, secretions can be removed in a very easy and hygienic manner, thus minimising the risk of contaminating the inner lumen of the tracheostomy tube.

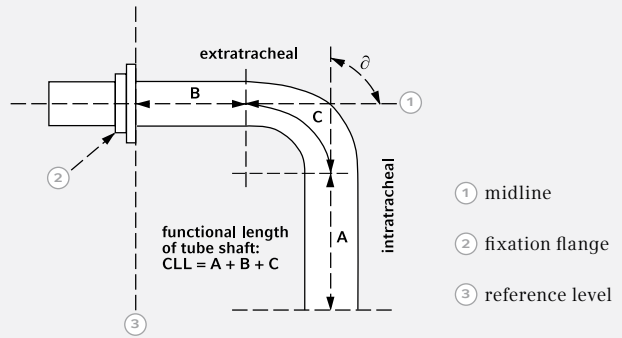

DIMENSIONS ACC. TO DIN EN ISO 5366-1 & 5366-3

TRACHEOFLEX

ARMoured TUBE MADE OF THERMOSENSITIVE PVC

- siliconised
- atraumatic tip
- fixed 15 mm connector
- radiopaque
- latex-free
- sterile
- single patient use

TRACHEOFLEX SET without cuff



SET COMPONENTS

- tracheostomy tube
- comfort neck band
- insertion aid
- movable fixation flange with screw threaded ring

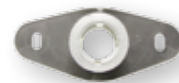

movable fixation flange with screw threaded ring

REF.	ORDER SIZE / I.D.	QTY
120502	3.0 - 6.0	5

TRACHEOFLEX TUBE

RÜSCH

ORDER SIZE / I. D.	O. D.	TOTAL LENGTH (CLL=A+B+C)	DIM. A	DIM. B	DIM. C	ANGLE (APPROX.)
3.0 mm	5.0 mm	45.0 mm	11.0 mm	15.0 mm	19.0 mm	90°
4.0 mm	6.0 mm	55.0 mm	14.0 mm	21.0 mm	20.0 mm	90°
5.0 mm	7.0 mm	59.0 mm	18.0 mm	19.0 mm	22.0 mm	90°
6.0 mm	8.4 mm	64.0 mm	21.0 mm	19.0 mm	24.0 mm	90°

TRACHEOFLEX S

ARMURED TUBE MADE OF THERMOSENSITIVE PVC

- siliconised
- atraumatic tip
- anatomically shaped (approx. 106°)
- with cuffed versions:
 - valve for Luer and Luer-lock syringe tips
 - blue pilot balloon
 - low-pressure cuff
- with or without phonation window
- soft, anatomically shaped fixation flange
- radiopaque
- latex-free
- sterile
- single patient use

SET COMPONENTS
multifunctional connector set with screw cap

- ① sealing cap
- ② phonation valve
- ③ 15 mm connector
- ④ cough cap
- ⑤ insertion aid
- ⑥ inner cannula

TRACHEOFLEX S TUBE

RUSCH

ORDER SIZE / I. D.	O. D.	TOTAL LENGTH (CLL=A+B+C)	DIM. A	DIM. B	DIM. C	ANGLE (APPROX.)	CUFF Ø	INNER CANNULA I. D. / O. D.
6.0 mm	9.4 mm	49.0 mm	18.0 mm	0 mm	31.0 mm	106°	18 mm	4.0 / 5.0 mm

TRACHEOFLEX S SET
with cuff, without phonation window

SET COMPONENTS

- tracheostomy tube
- 15 mm connector
- cough cap
- 2 inner cannulas
- comfort neck band
- insertion aid

REF.	ORDER SIZE	QTY
120000	6.0	2

TRACHEOFLEX S SET
with cuff, with phonation window

SET COMPONENTS

- tracheostomy tube
- phonation valve
- sealing cap
- 15 mm connector
- cough cap
- 2 inner cannulas
- comfort neck band
- insertion aid

REF.	ORDER SIZE	QTY
120001	6.0	2

TRACHEOFLEX S SET

without cuff, without phonation window



SET COMPONENTS

- tracheostomy tube
- 15 mm connector
- cough cap
- 2 inner cannulas
- comfort neck band
- insertion aid

REF.	ORDER SIZE / I.D.	QTY
120100	6.0	2

TRACHEOFLEX S SET

without cuff, with phonation window



SET COMPONENTS

- tracheostomy tube
- phonation valve
- sealing cap
- 15 mm connector
- cough cap
- 2 inner cannulas
- comfort neck band
- insertion aid

REF.	ORDER SIZE / I.D.	QTY
120101	6.0	2

Caution: When using tracheostomy tubes without a phonation window, the phonation valve should not be attached when the cuff is blocked (airway obstruction). When using a phonation valve or a sealing cap, only use tracheostomy tubes with a phonation window and deflate any cuffs prior to use. Also remove the inner cannula, if present, from the tube first.

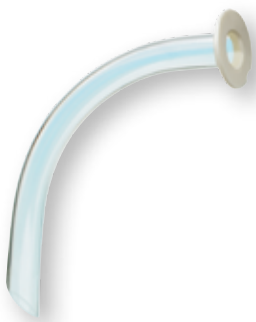

TRACHEOFLEX S INNER CANNULA

- without phonation opening
- atraumatic olive tip
- with low-profile connector
- sterile
- single use

Fixation through accessories, such as e.g. the 15 mm connector or the cough cap.

TRACHEOFLEX S INNER CANNULA

RÜSCH

REF.	ORDER SIZE	I. D.	O. D.	QTY
858135	6.0	4.0 mm	5.0 mm	1

TRACFLEX PLUS

ARMoured TUBE MADE OF THERMOSENSITIVE PVC, DEHP-FREE

- atraumatic tip
- with cuffed versions:
 - valve for Luer and Luer-lock syringe tips
- with valve sealing cap
 - blue pilot balloon
 - low-pressure cuff
- fixed 15 mm connector
- soft, movable, colour-coded fixation flange with unique safe locking mechanism
- radiopaque
- latex-free, DEHP-free
- sterile
- single patient use

SET COMPONENTS

- ① 2 flexible inner cannulas with colour-coded stopper
- ② insertion aid (obturator)
- ③ comfort neck band
- ④ shower cap
- ⑤ cough cap
- ⑥ water-soluble lubricating jelly, 3g sachet
- ⑦ tracheostomy tube patient card

TRACFLEX PLUS TUBE

RÜSCH

ORDER SIZE / I. D.	O. D.	TOTAL LENGTH (CLL=A+B+C)	DIM. A	DIM. B	DIM. C	ANGLE (APPROX.)	CUFF Ø*
3.0 mm	5.3 mm	46.5 mm	21.1 mm	7.5 mm	17.9 mm	105°	–
4.0 mm	6.1 mm	56.5 mm	20.7 mm	9.5 mm	26.3 mm	105°	–
5.0 mm	7.6 mm	59.0 mm	24.0 mm	7.0 mm	28.0 mm	105°	14 mm
6.0 mm	8.6 mm	64.0 mm	27.9 mm	7.0 mm	29.1 mm	105°	18 mm

* only for 121903 Tracflex Plus Set

TRACFLEX PLUS INNER CANNULAS

- colour coded stopper
- sterile
- single use

TRACFLEX PLUS INNER CANNULA

RÜSCH

REF.	ORDER SIZE	I. D.	O. D.	QTY
121910-000060	6.0	5.0	5.7	10

TRACFLEX PLUS SET
with cuff



SET COMPONENTS

- tracheostomy tube
- 2 flexible inner cannulas with colour-coded stopper
- insertion aid (obturator)
- comfort neck band
- shower cap
- cough cap
- water-soluble lubricating jelly, 3g sachet
- tracheostomy tube patient card

REF.	ORDER SIZE / I.D.	QTY
121903	5.0 – 6.0	2

TRACHEOFLEX S SET
without cuff







SET COMPONENTS

- tracheostomy tube
- 2 flexible inner cannulas with colour-coded stopper
- insertion aid (obturator)
- comfort neck band
- shower cap
- cough cap
- water-soluble lubricating jelly, 3g sachet
- tracheostomy tube patient card

REF.	ORDER SIZE / I.D.	QTY
121900	3.0 – 6.0	2

TRACFLEX PLUS ACCESSORIES

RUSCH

	REF.	DESCRIPTION	QTY
	121911	Shower cap for TracFlex Plus tubes, acting as a splash guard to prevent the entry of inhalation of water droplets during bathing or showering	4
	121912	Cough cap for TracFlex Plus tubes, to channel expelled secretions downwards	4
	121913	Sealing cap for TracFlex Plus tubes, for weaning therapy	4
	121915 *	Insertion aid for safe and atraumatic introduction of the TracFlex Plus tracheostomy tube	1

* When ordering, please also indicate tube size

STANDARD TRACHEOSTOMY TUBES

Teleflex's CrystalClear Plus tracheostomy tubes from RÜSCH are distinguished by top quality, safety, comfort and economy. The soft plastic material adapts perfectly to the child's anatomy. Including an open and transparent fixation flange and an integrated rotating connector, they

ensure the greatest safety and comfort for the small child. The CrystalClear Plus tracheostomy tube is for single use only and therefore especially suitable for children with an infection. The tubes are available with and without cuffs and also come in intermediate sizes.

CRYSTALCLEAR PLUS

ADVANCED TUBE SYSTEM WITH A FLEXIBLE INNER CANNULA SYSTEM, MADE OF THERMOSENSITIVE PVC

The Teleflex CrystalClear Plus tracheostomy tube set from RÜSCH is an advanced tube system with a flexible inner cannula system. Secretions are removed simply and efficiently at an early stage of accumulation through frequent changes of the inner cannula, while protecting the inner tube lumen against contamination.

- integrated rotating 15 mm connector
- with cuffed versions:
 - valve for Luer and Luer-lock syringe tips
 - blue pilot balloon
 - low-pressure cuff
- colour-coded tube neckplate
- continuous X-ray marker along the tube shaft
- latex-free
- sterile
- single use

AVAILABLE SET COMPONENTS

- ① 2 flexible inner cannulas with colour-coded stopper starting from size 6
- ② insertion aid (obturator), starting from size 6
- ③ soft tracheostomy tube neck band
- ④ water-soluble lubricating jelly, 3 g sachet

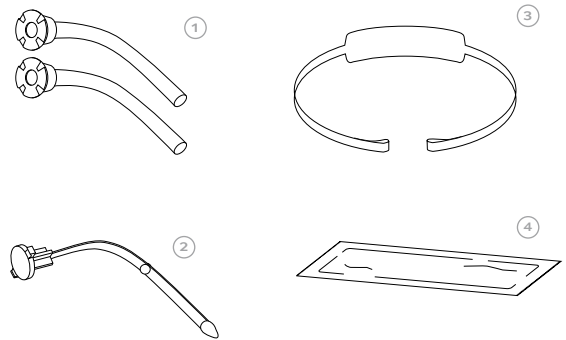

CRYSTALCLEAR PLUS TUBE

RÜSCH

ORDER SIZE / I. D.	O. D.	TOTAL LENGTH (CLL=A+B+C)	DIM. A	DIM. B	DIM. C	ANGLE (APPROX.)	CUFF Ø *	INNER CANNULA I. D./O. D.	COLOUR CODE
3.5 mm	5.3 mm	47.0 mm	17.0 mm	0 mm	30.0 mm	95°	11 mm	—	red
4.0 mm	5.9 mm	54.0 mm	18.0 mm	0 mm	36.0 mm	95°	12 mm	—	white
4.5 mm	6.5 mm	54.0 mm	19.0 mm	0 mm	35.0 mm	95°	14 mm	—	grey
5.0 mm	7.0 mm	57.0 mm	20.0 mm	0 mm	37.0 mm	95°	14 mm	—	blue
5.5 mm	7.5 mm	58.0 mm	20.0 mm	0 mm	38.0 mm	95°	15 mm	—	green
6.0 mm	8.7 mm	64.0 mm	25.5 mm	0 mm	38.5 mm	95°	19 mm	6.0 mm	orange
6.5 mm	8.7 mm	64.0 mm	25.5 mm	0 mm	38.5 mm	95°	19 mm	6.5 mm	red

* only 121303

CRYSTALCLEAR PLUS SET
with cuff

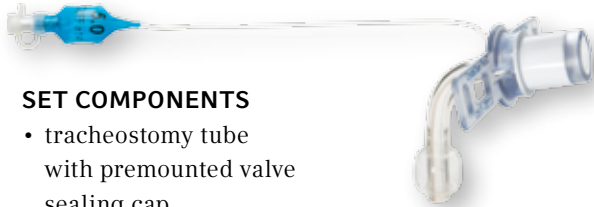

SET COMPONENTS

- tracheostomy tube with premounted valve sealing cap
- 2 flexible inner cannulas with colour-coded stopper (≥ size 6)
- soft neck band
- insertion aid (obturator) (≥ size 6)
- water-soluble lubricating jelly, 3 g sachet

REF.	ORDER SIZE / I.D.	QTY
121303	3.5 – 6.5	5

CRYSTALCLEAR PLUS SET
without cuff



SET COMPONENTS

- tracheostomy tube
- 2 flexible inner cannulas with colour-coded stopper (≥ size 6)
- soft neck band
- insertion aid (obturator) (≥ size 6)
- water-soluble lubricating jelly, 3 g sachet

REF.	ORDER SIZE / I.D.	QTY
121300	3.5 – 6.5	5

CRYSTALCLEAR PLUS INNER CANNULA

- colour-coded stopper
- sterile
- single use

CRYSTALCLEAR PLUS INNER CANNULA

RUSCH



REF.	ORDER SIZE	I.D.	O.D.	TOTAL LENGTH	INSERTION LENGTH	SIZE IMPRINT ON STOPPER	COLOUR CODE	QTY
121310	6.0	5.0 mm	5.7 mm	91.5	88.5	6.0	orange	10
	6.5	5.0 mm	5.7 mm	91.5	88.5	6.5	red	10

CRYSTALCLEAR PLUS ACCESSORIES

- single use

CRYSTALCLEAR PLUS CAP

RUSCH

	REF.	DESCRIPTION	QTY
	121311	Shower cap for CrystalClear Plus tube, acting as a splash guard to prevent the entry or inhalation of water droplets during bathing or showering	4
	121312	Cough cap for CrystalClear Plus tubes, to channel expelled secretions downwards	4
	121313	Sealing cap for CrystalClear Plus tubes, for weaning therapy	4

PRESHAPED TRACHEOSTOMY TUBE

Tracheostomy tubes for paediatrics are anatomically designed and manufactured with particular care. The atraumatic tip is gentle to the mucosa and facilitates gentle introduction, while the thermoplastic material conforms optimally to the child's anatomy.

With our years of experience in the development of “small” tubes, we help to make tracheostomy as comfortable and safe as possible for children. The Teleflex RÜSCH Biesalski tracheostomy tube is a specially preshaped tube that meets their differing demands.

BIESALSKI

PRESHAPED TRACHEOSTOMY TUBE MADE OF THERMOSENSITIVE PVC

The Biesalski tube provides uncomplicated handling. In just a few movements, the inner cannula can be exchanged. Components such as standard connector, cough cap or phonation valve are connected securely to the tracheostomy tube by means of a bayonet fastener. The special form of the Biesalski tube makes it possible to use it also as a phonation cannula which does not require a phonation opening. The tube is thus highly suited to supporting the child during speech therapy.

- in the form of an arc, tapered
- soft anatomically shaped fixation flange
- colour coding
- latex-free
- sterile
- single patient use

BIESALSKI SET without cuff



SET COMPONENTS

- tracheostomy tube
- comfort neck band
- multifunctional connector set with bayonet fastener
 - 15 mm connector
 - phonation valve
 - cough cap
 - 2 colour-coded inner cannulas made of PVC

REF.	ORDER SIZE / I.D.	QTY
120900	4.0 – 6.0	5

BIESALSKI TUBE

RÜSCH

ORDER SIZE / I.D.	O.D. (TIP)	O.D. (BEHIND FIXATION FLANGE)	TOTAL LENGTH (CLL=A+B+C)	DIM. A	DIM. B	DIM. C	ANGLE (APPROX.)	INNER CANNULA I.D. / O.D.	COLOUR CODE
4.0 mm	5.2 mm	7.15 mm	47.0 mm	0 mm	0 mm	47.0 mm	90°	2.7 / 3.7 mm	white
5.0 mm	6.2 mm	8.2 mm	55.0 mm	0 mm	0 mm	55.0 mm	90°	3.7 / 4.7 mm	green
6.0 mm	7.2 mm	9.25 mm	62.8 mm	0 mm	0 mm	62.8 mm	90°	4.6 / 5.6 mm	orange

SPECIAL PRODUCTS

The perfectly coordinated special sets from Teleflex's RÜSCH brand put everything in the correct size and in sterile packaging within easy grasp for every application.

This enables you to be prepared for everything from an emergency to the operating theatre and allows optimal care of the child, as well as safe and economical work.

TPS MULTIFLEX

ARMoured TRACHEOSTOMY RETAINER

TPS MultiFlex is used to gently shorten the weaning phase of tracheostomised children and to train them to start using their upper airways again. The tracheostoma retainer is characterised by high patient tolerability as well as simple and safe handling.

- armoured retainer with intratracheal disc, made of silicone
- evenly spaced armoured sections to allow for length alteration
- latex-free
- sterile
- single patient use

TPS MULTIFLEX RÜSCH		
ORDER SIZE / I. D.	O. D.	TOTAL LENGTH (CLL=A+B+C)
6.0 mm	8.3 mm	110.0 mm

TPS MULTIFLEX SET



SET COMPONENTS

- tracheostomy retainer
- sealing cap made of silicone
- 15 mm connector
- movable fixation flange with screw threaded ring
- comfort neck band

REF.	ORDER SIZE / I. D.	QTY
120460	6.0	1

TRACHEOQUICK

EMERGENCY CONIOTOMY SET

The TracheoQuick Set contains everything needed for rapid intervention in the case of obstruction of the upper respiratory tract, when intubation or ventilation are not possible.

- pre-assembled coniotomy set, ready to use
- conical introduction dilator made of stainless steel
- coniotomy tube made of plastic
- 15 mm connector
- fixation plate
- mounted stopper
- latex-free
- sterile
- single use

TRACHEOQUICK RÜSCH		
ORDER SIZE / I. D.	O. D.	TOTAL LENGTH (CLL=A+B+C)
2.0 mm	2.8 mm	29.6

TRACHEOQUICK SET



SET COMPONENTS

- coniotomy tube
- flexible tube extension made of silicone with connectors
- scalpel
- one-way syringe and comfort neck band pre-assembled with tube

REF.	ORDER SIZE / I. D.	QTY
120600	2.0	1

ACCESSORIES

Once tracheostomy tube cannulation has been safely accomplished, fixation and humidification, tracheostomy care and rehabilitation become important parameters. From secure cuff pressure monitoring to high performance filtration media to keep the airway's mucosiliary

system functioning efficiently, and from ultra-soft neck-bands for comfortable and safe tube fixation to cleaning equipment for daily care, Teleflex offers a large range of accessories to meet day-to-day needs, and to make tracheostomy as safe and comfortable as possible.

BLUE COMFORT NECK BAND

	REF.	DESCRIPTION	QTY
	507800	<ul style="list-style-type: none"> • extra small version • single use 	10

TRACHFIT NECK BAND

	REF.	DESCRIPTION	QTY
	968671	<ul style="list-style-type: none"> • beige coloured • 3-piece neck band for tracheostomy tubes • progressively adjustable and easily positioned • velcro fastener, secure and easy to fix, latex-free • sterile • single use • individually packed 	10

WHITE COMFORT NECK BAND, SIZE L

	REF.	DESCRIPTION	QTY
	507906	<ul style="list-style-type: none"> • 2-piece neck band for tracheostomy tubes • progressively adjustable and easily positioned • velcro fastener, secure and easy to fix • non-irritant with cotton exterior and moisture-transporting soft inner layer • specially designed for prolonged use and patients with sensitive skin • latex-free • ready to use • single use • individually packed 	20

SPIRO

	REF.	DESCRIPTION	QTY
	121800	Spiro phonation valve set consisting of: <ul style="list-style-type: none"> • housing with phonation valve and filter • housing with filter, without phonation valve • deflector • connectors for silver cannulas • tweezers • with oxygen port • single patient use 	1
	121801	Spiro filter housing with phonation valve <ul style="list-style-type: none"> • single patient use 	5
	121802	Spiro filter housing without phonation valve <ul style="list-style-type: none"> • single patient use 	5
	121803	Spiro filter for Spiro filter housing 121800/121801/121802 <ul style="list-style-type: none"> • single patient use 	100
	121804	Spiro deflector <ul style="list-style-type: none"> • single patient use 	5

FORCEPS

	REF.	DESCRIPTION	QTY
	968674-000010	forceps, angular	1

TRACHEAL DILATOR

	REF.	DESCRIPTION	QTY
	968674-000020	tracheal dilator, 3 branches	1

CLEANING BRUSH

	REF.	DESCRIPTION	QTY
	968675	size 6 for tube I.D. 3-6 mm	10

TRACHJELL

	REF.	DESCRIPTION	QTY
	556100	<ul style="list-style-type: none"> • single dose water-soluble lubricating gel • 8.5 g • sterile 	25

ENDOTEST

	REF.	DESCRIPTION	QTY
	112700	Device for filling and monitoring the pressure of low-pressure cuffs on tracheal, tracheostomy and bronchial tubes and laryngeal masks <ul style="list-style-type: none"> • with connecting tube 	1
	230100	Connecting tube made of PVC for ENDOTEST cuff pressure monitoring device <ul style="list-style-type: none"> • transparent, latex-free, with Luer adapter (male and female) • approx. 100 cm long, 2.0 x 3.0 mm 	1

PAEDIATRIC TRACHEOSTOMY MASK

	REF.	DESCRIPTION	QTY
	41076	<ul style="list-style-type: none"> • for aerosol therapy with children • swivel connector 	50



AIRWAY MANAGEMENT

Teleflex's rüsch range covers the full spectrum of airway needs with products for any situation. These are also provided in small sizes to cater for paediatric care. The optimum tube for every application makes even difficult intubation easy, and a large choice of accessories means everything you need for infants and children is available from one source. More than 100 years of know-how in product development, specialisation and production experience have gone into every article we supply. Close cooperation with well-known clinics and medical experts from all fields guarantees quality standards and development competences that are unparalleled throughout the world.

COLD LIGHT LARYNGOSCOPES

Light quality and light yield constitute decisive criteria when selecting a laryngoscope system. It is our aim to put the most suitable system at your disposal. Our range of paediatric applications includes a choice of reusable as well as disposable product systems to meet all requirements. All handles comply with international

standards. Replacement of the light holder alone can save a substantial amount of money. No matter what situation, condition or patient anatomy you are confronted with – our laryngoscopes are the perfect instruments for all types of intubation.

BLADES

METAL AND PLASTIC LARYNGOSCOPE BLADES

The top quality blades are optimally adapted to xenon and LED fibreoptic laryngoscopes. The extremely large diameter fibreglass light holder is integrated in the blade. This design principle enables easy care, low-maintenance and compact blade forms. Both alternatives focus the light ray directly in front of the blade tip. The excellent illumination achieved through xenon light ensures a high level of confidence and safety during intubation. LED provides the best quality and tone of light for perfect illumination of the vocal cords to facilitate tube insertion.



BLADES

RÜSCH

	REF.	ORDER SIZE	DESCRIPTION	QTY
	670000	0/1/2/3/4/5	<ul style="list-style-type: none"> • according to Macintosh • metal • reusable 	1
	670060	0/1/2/3/4	<ul style="list-style-type: none"> • according to Miller • metal • reusable 	1
	670050	0/1/2/3/4	<ul style="list-style-type: none"> • according to Foregger • metal • reusable 	1
	670001	small/medium/large	<ul style="list-style-type: none"> • paediatric • metal • reusable 	1
	670166	2/3/4	<ul style="list-style-type: none"> • according to Macintosh • plastic • sterile • single use 	10
	670167	2/3/4	<ul style="list-style-type: none"> • according to Macintosh • plastic • single use 	20
	670166	0/1	<ul style="list-style-type: none"> • according to Miller • plastic • sterile • single use 	10
	670167	0/1	<ul style="list-style-type: none"> • according to Miller • plastic • single use 	20

SAFEVIEW BLADE WITH SAFEVIEW PROTECTION SHEATH

DISPOSABLE METAL AND PLASTIC BLADES





SIMPLICITY, EFFICACY, SECURITY – ALL IN ONE

The blade is of high rigidity. Its optimised profile and gliding properties facilitate the insertion of the instrument. Its high luminosity guarantees optimal visibility. Each Safeview blade is already inserted in an individual protection sheath which reduces the risks of cross-contamination for patient and staff. It protects the handle from getting in contact with secretions or blood during and after intubation. Safeview blades are easy and rapid to use, even in case of emergency. When seconds count, you can count on Safeview.



SAFEVIEW BLADE WITH PROTECTION SHEATH

RUSCH

	REF.	ORDER SIZE	DESCRIPTION	QTY
	670504	1/2/3/4	<ul style="list-style-type: none"> • according to Macintosh • plastic • single use 	10/10/20/20
	670505	0/1/2	<ul style="list-style-type: none"> • according to Miller • plastic • single use 	10
	670150	0/1/2/3/4	<ul style="list-style-type: none"> • according to Macintosh • metal • single use 	10
	670185	00/0/1/2/3/4	<ul style="list-style-type: none"> • according to Miller • metal • single use 	10

USAGE OF SAFEVIEW BLADES WITH PROTECTION SHEATH



- ① Connect the blade in its protection sheath onto the handle. Maintain sheath at connection side and tear out the pre-cut tip of the sheath.
- ② Protect the handle by sliding the sheath over it.
- ③ Once intubation is completed, slide the sheath back onto the blade and dispose of it.

HANDLES

REUSABLE METAL HANDLES, XENON AND LED LIGHT

LED light

- high performance LED: > 50,000 lux
- quick to use, maintenance-free
- white light: 5,500 K
- LED operating time: > 50,000 hours
- safe handling and easy service – also for EMS
- simple cleaning, complete autoclavable
- battery operation time: 2 hours at maximum quantity of light



HANDLE CASING

RÜSCH

REF.	ORDER SIZE	DESCRIPTION	VE
670006	adult/paediatric	handle casing	1

BATTERY INSERTS FOR HANDLE

670057	adult	Lithium-ion storage battery cartridge for handle casing (with lid and LED light) <ul style="list-style-type: none"> • minimum self-discharge • no memory effect 	1
670049	adult/paediatric	battery container for handle casing (including battery, lid and xenon light)	1

HANDLE SPARE PARTS

670011	-	xenon light	6
670007	adult/paediatric	lid for handle casing	1
670008	adult/paediatric	battery container for handle casing (without battery and without light)	1
670053	-	actuator for handle	5

HANDLE ACCESSORIES

670019	-	Inductive battery charger with automatic cut-off function: <ul style="list-style-type: none"> • recharges up to two batteries at a time • maintenance-free thanks to contactless inductive charging, charger errors due to corrosion can be eliminated • packed handles are also chargeable • automatic switch-off function reduces risk of overcharging the battery 	1
--------	---	--	---

LARYNGOSCOPE HANDLE

WITH NON-RECHARGEABLE BATTERIES, REUSABLE METAL HANDLE

LED light

- intensity of LED lamp: > 9,000 lux
- LED operating time: > 10,000 hours

Power source

- two 1.5V AA size alkaline batteries

METAL HANDLE

RÜSCH

REF.	ORDER SIZE	DESCRIPTION	QTY
670067-000010	paediatric (thin)	LED handle, no batteries included	1



LED LARYNGOSCOPE KIT

SINGLE-USE METAL LARYNGOSCOPE HANDLE + BLADE

A full single-use kit is now available from RÜSCH, including a high-quality metal LED handle and metal blades in all shapes and sizes.

The blade is made of medical grade materials and designed for nearly all patient anatomies.

The fiberoptic light source is fully sheathed to avoid light dispersion and ensure better illumination of the vocal cords.

LED light

- intensity of LED lamp: > 5,000 lux
- LED operating time: > 10,000 hours

Power source

- one 1.5 V size alkaline button cell



Single-use blade and single-use handle are delivered in one pack; if handle & blade are not used at the same time, they can be unpacked separately.

FULLY SHEATHED FIBROPTICS



Macintosh



Miller

LED LARYNGOSCOPE KIT, SINGLE USE

RÜSCH

REF.	ORDER SIZE	DESCRIPTION	QTY
670160	1/2/3/4	handle and blade according to Macintosh	10
670190	00/0 /1/2	handle and blade according to Miller	10

HANDLE AND BLADES ALSO AVAILABLE SEPARATELY

LED LARYNGOSCOPE, SINGLE USE

RÜSCH

REF.	ORDER SIZE	DESCRIPTION	QTY
670195	-	handle	10
670161	1/2/3/4	blade according to Macintosh	10
670191	00/0 /1/2	blade according to Miller	10

ENDOTRACHEAL TUBES

To meet the special requirements of paediatric patients, RÜSCH supplies a large variety of tracheal and bronchial tubes in different shapes and made from different materials. All our tubes feature an outstanding ID to OD ratio. High-grade materials tested according to medical criteria

reflect our high quality standards. For example, our latest Safety Silk Series for the most demanding patients is made of extremely soft and flexible, yet kink-resistant PVC, thus ensuring easy and safe intubation.

SUPER SAFETYCLEAR TRACHEAL TUBE

- made of PVC
- low-pressure cuff
- cupped atraumatic tip
- semi-seated connector
- continuous X-ray marker
- blue pilot balloon
- valve for Luer and Luer-lock syringes
- black position indicator for correct tube placement
- graduated
- latex-free
- sterile
- single use

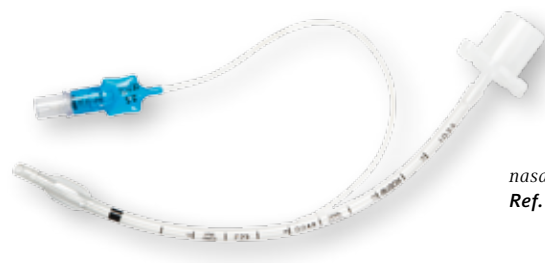

nasal/oral (Magill)
Ref. 112480



*nasal/oral (Murphy),
1 eye*
Ref. 112482

SUPER SAFETYCLEAR

RÜSCH

REF.	ORDER SIZE/I.D.	O.D.	CUFF Ø	LENGTH*	QTY
112480, Magill	2.5 mm	4.0 mm	8.0 mm	160 mm	10
112482, Murphy	3.0 mm	5.0 mm	8.0 mm	170 mm	10
	3.5 mm	5.3 mm	8.0 mm	190 mm	10
	4.0 mm	6.0 mm	10.5 mm	210 mm	10
	4.5 mm	6.3 mm	10.5 mm	230 mm	10
	5.0 mm	6.7 mm	13.0 mm	250 mm	10
	5.5 mm	7.3 mm	16.5 mm	280 mm	10
	6.0 mm	8.0 mm	18.5 mm	290 mm	10
	6.5 mm	8.7 mm	20.5 mm	300 mm	10

* Length without connector

SUPER SAFETY SILK

TRACHEAL TUBE, DEHP-FREE

Part of the Safety Silk Series family

Clear tracheal tube made of SOFT PVC

- nasal/oral
- 1 eye (Murphy)
- tissue-friendly thermoplastic material, especially advantageous for long-term intubation
- soft atraumatic tip
- high-volume cuff
- bonded connector
- continuous X-ray marker
- low pressure sealing
- Safety Silk surface
- black position indicator for intubation depth control
- latex-free
- sterile
- single use



SUPER SAFETY SILK

RUSCH

REF.	ORDER SIZE/I.D.	O.D.	CUFF Ø	LENGTH	QTY
112682, Murphy, 1 eye sizes: I.D. 3.0–6.0 mm	3.0 mm	5.0 mm	8.0 mm	170 mm	10
	3.5 mm	5.3 mm	8.0 mm	190 mm	10
	4.0 mm	6.0 mm	10.5 mm	220 mm	10
	4.5 mm	6.3 mm	10.5 mm	230 mm	10
112680, Magill sizes: I.D. 5.0–6.0 mm	5.0 mm	7.3 mm	16.5 mm	250 mm	10
	5.5 mm	8.0 mm	18.5 mm	280 mm	10
	6.0 mm	8.7 mm	20.5 mm	290 mm	10

PEDI SAFETY SILK

TRACHEAL TUBE

Part of the Safety Silk Series family
Clear tracheal tube made of SOFT PVC

- nasal/oral (Magill)
- tissue-friendly thermoplastic material,
- cupped atraumatic black tip
- especially advantageous for long-term intubation
- semi-seated connector
- continuous X-ray marker
- graduated
- latex-free
- sterile
- single use



PEDI SAFETY SILK

RUSCH

REF.	ORDER SIZE/I.D.	O.D.	LENGTH*	QTY
100480	2.0 mm	3.3 mm	140 mm	10
	2.5 mm	4.0 mm	160 mm	10
	3.0 mm	4.7 mm	180 mm	10
	3.5 mm	5.3 mm	200 mm	10
	4.0 mm	6.0 mm	220 mm	10
	4.5 mm	6.7 mm	240 mm	10
	5.0 mm	7.3 mm	260 mm	10
	5.5 mm	8.0 mm	280 mm	10

SAFETYCLEAR

TRACHEAL TUBE

- made of PVC
- cupped atraumatic black tip
- semi-seated connector
- continuous X-ray marker
- graduated
- latex-free
- sterile
- single use



SAFETYCLEAR

RUSCH

REF.	ORDER SIZE/I.D.	O.D.	LENGTH*	QTY
100380, Magill 100382, Murphy	2.0 mm	3.0 mm	150 mm	10
	2.5 mm	3.3 mm	160 mm	10
	3.0 mm	4.0 mm	170 mm	10
	3.5 mm	4.7 mm	190 mm	10
	4.0 mm	5.3 mm	210 mm	10
	4.5 mm	6.0 mm	230 mm	10
	5.0 mm	6.7 mm	250 mm	10
	5.5 mm	7.3 mm	280 mm	10
	6.0 mm	8.0 mm	290 mm	10
	6.5 mm	8.7 mm	300 mm	10

* Length without connector

NASAL SAFETY SILK

ANATOMICALLY SHAPED TRACHEAL TUBE, DEHP-FREE

Part of the Safety Silk Series family, clear tracheal tube made of SOFT PVC

- nasal
- 1 eye (Murphy)
- tissue-friendly thermoplastic material, especially advantageous for long-term intubation
- cupped atraumatic tip
- low-pressure cuff
- bonded connector
- continuous blue X-ray marker
- kink-resistant
- graduated
- blue pilot balloon
- valve for Luer and Luer-lock syringes
- latex-free
- single use

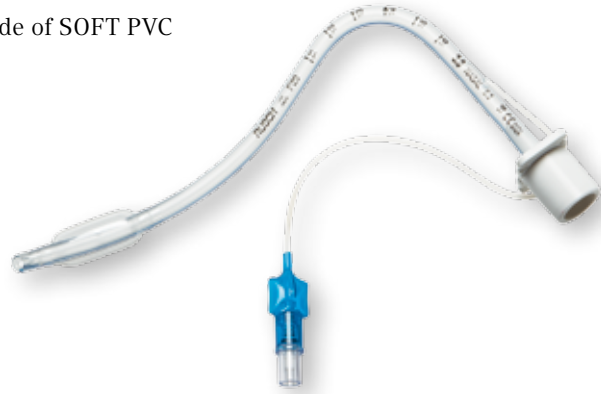

NASAL SAFETY SILK

RUSCH

REF.	ORDER SIZE/I.D.	O.D.	CUFF Ø	LENGTH*	QTY
111782	3.0 mm	5.3 mm	11.0 mm	240 mm	10
	3.5 mm	6.0 mm	11.0 mm	271 mm	10
	4.0 mm	6.3 mm	13.0 mm	303 mm	10
	4.5 mm	6.7 mm	13.0 mm	338 mm	10
	5.0 mm	7.3 mm	16.0 mm	358 mm	10
	5.5 mm	8.0 mm	18.0 mm	368 mm	10
	6.0 mm	8.7 mm	20.0 mm	415 mm	10
	6.5 mm	9.3 mm	24.0 mm	420 mm	10

* Length without connector

AGT TUBES, ORAL

CLEAR ANATOMICALLY SHAPED TRACHEAL TUBE WITH CUFF

- oral
- 1 eye
- made of PVC
- cupped atraumatic tip
- low-pressure cuff and blue pilot balloon
- semi-seated connector
- continuous X-ray marker
- valve for Luer and Luer-lock syringe tips
- graduated
- latex-free
- sterile
- single use

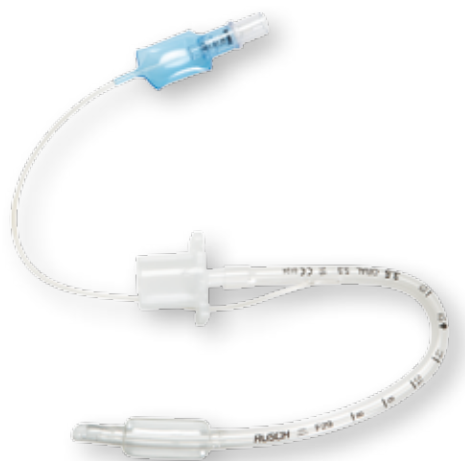

AGT TUBES

RUSCH

REF.	ORDER SIZE/I.D.	O.D.	CUFF Ø	LENGTH*	RECOMMENDED SIZE FOR	QTY
111780	3.5 mm	5.3 mm	11 mm	120 mm	1–6 months	10
	4.0 mm	6.0 mm	11 mm	130 mm	1/2–1 year	10
	4.5 mm	6.3 mm	13 mm	145 mm	1–2 years	10
	5.0 mm	6.7 mm	13 mm	155 mm	2–4 years	10
	5.5 mm	7.3 mm	16 mm	165 mm	4–6 years	10
	6.0 mm	8.0 mm	18 mm	180 mm	6–8 years	10
	6.5 mm	8.7 mm	20 mm	190 mm	8–9 years	10

CLEAR ANATOMICALLY SHAPED TRACHEAL TUBE WITHOUT CUFF

- oral
- 2 eyes
- made of PVC
- cupped atraumatic tip
- semi-seated connector
- continuous X-ray marker
- graduated
- latex-free
- sterile
- single use



AGT TUBES

RUSCH

REF.	ORDER SIZE/I.D.	O.D.	LENGTH*	RECOMMENDED SIZE FOR	QTY
100180	3.0 mm	4.0 mm	105 mm	newborn babies	10
	3.5 mm	4.7 mm	120 mm	1–6 months	10
	4.0 mm	5.3 mm	130 mm	1/2–1 year	10
	4.5 mm	6.0 mm	145 mm	1–2 years	10
	5.0 mm	6.7 mm	155 mm	2–4 years	10
	5.5 mm	7.3 mm	165 mm	4–6 years	10
	6.0 mm	8.0 mm	180 mm	6–8 years	10
	6.5 mm	8.7 mm	190 mm	8–9 years	10

* Length without connector

AGT TUBES, NASAL

CLEAR ANATOMICALLY SHAPED TRACHEAL TUBE WITH CUFF

- nasal
- 1 eye
- made of PVC
- cupped atraumatic tip
- low-pressure cuff and blue pilot balloon
- semi-seated connector
- continuous X-ray marker
- valve for Luer and Luer-lock syringes
- graduated
- latex-free
- sterile
- single use



AGT TUBES

RUSCH

REF.	ORDER SIZE/I.D.	O.D.	CUFF Ø	LENGTH*	RECOMMENDED SIZE FOR	QTY
111781	3.5 mm	5.3 mm	11 mm	160 mm	1–6 months	10
	4.0 mm	6.0 mm	11 mm	185 mm	1/2–1 year	10
	4.5 mm	6.3 mm	13 mm	220 mm	1–2 years	10
	5.0 mm	6.7 mm	13 mm	235 mm	2–4 years	10
	5.5 mm	7.3 mm	16 mm	245 mm	4–6 years	10
	6.0 mm	8.0 mm	18 mm	260 mm	6–8 years	10
	6.5 mm	8.7 mm	20 mm	270 mm	8–9 years	10

CLEAR ANATOMICALLY SHAPED TRACHEAL TUBE WITHOUT CUFF

- nasal
- 2 eyes
- made of PVC
- cupped atraumatic tip
- semi-seated connector
- continuous X-ray marker
- graduated
- latex-free
- sterile
- single use



AGT TUBES

RUSCH

REF.	ORDER SIZE/I.D.	O.D.	LENGTH*	RECOMMENDED SIZE FOR	QTY
100181	3.0 mm	4.0 mm	115 mm	newborn babies	10
	3.5 mm	4.7 mm	140 mm	1–6 months	10
	4.0 mm	5.3 mm	155 mm	1/2–1 year	10
	4.5 mm	6.0 mm	180 mm	1–2 years	10
	5.0 mm	6.7 mm	190 mm	2–4 years	10
	5.5 mm	7.3 mm	195 mm	4–6 years	10
	6.0 mm	8.0 mm	205 mm	6–8 years	10
	6.5 mm	8.7 mm	210 mm	8–9 years	10

* Length without connector

RÜSCHFLEX

ARMOURED TRACHEAL TUBE

- nasal/oral
- 1 eye (Magill / Murphy)
- curved
- made of PVC
- low-pressure cuff
- fixed white connector
- blue pilot balloon
- valve for Luer- and Luer-lock syringe tips
- radiopaque
- graduated
- latex-free
- sterile
- single use

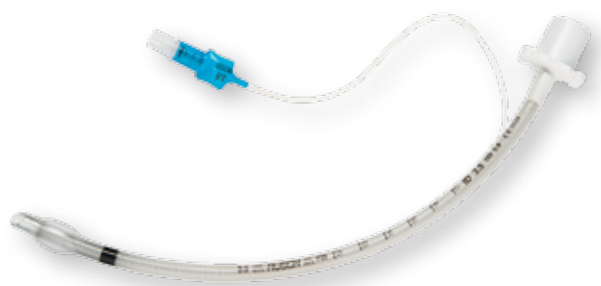

Magill, Ref. 104201
Murphy, 1 eye, Ref. 104202

RÜSCHFLEX

RÜSCH

REF.	ORDER SIZE/I.D.	O.D.	LENGTH MAGILL*	LENGTH MURPHY*	QTY
104201, Magill 104202, Murphy	3.5 mm	5.8 mm	220 mm	222 mm	5
	4.0 mm	6.3 mm	231 mm	233 mm	5
	4.5 mm	6.8 mm	255 mm	257 mm	5
	5.0 mm	7.3 mm	312 mm	314 mm	5
	5.5 mm	7.8 mm	318 mm	320 mm	5
	6.0 mm	8.4 mm	328 mm	331 mm	5
	6.5 mm	9.0 mm	334 mm	338 mm	5

* Length without connector



with FlexiSlip
Magill, 1 eye Ref. 104203
Murphy, 1 eye Ref. 104204

RÜSCHFLEX WITH FLEXISLIP

RÜSCH

REF.	ORDER SIZE/I.D.	O.D.	LENGTH MAGILL*	LENGTH MURPHY*	QTY
104203, Magill 104204, Murphy	5.0 mm	7.3 mm	312 mm	314 mm	5
	5.5 mm	7.8 mm	318 mm	320 mm	5
	6.0 mm	8.4 mm	328 mm	331 mm	5
	6.5 mm	9.0 mm	334 mm	338 mm	5

* Length without connector

SILKOCLEAR FLEX

ARMOURED TRACHEAL TUBE

- nasal/oral
- 1 eye (Murphy)
- made of silicone
- smooth inner tube coating
- highly flexible thin-walled cuff
- fixed connector
- pilot balloon
- black position indicator for correct tube placement
- valve for Luer and Luer-lock syringe tips
- graduated
- latex-free
- sterile



PLEASE NOTE:
SILKOSPRAY is not suitable for devices made of silicone. As a lubricant, we recommend commercially available gels.

SILKOCLEAR FLEX

RÜSCH

REF.	ORDER SIZE/I.D.	O.D.	CUFF Ø	LENGTH*	QTY
105702	3.5 mm	5.0 mm	7.0 mm	226.0 mm	2
	4.0 mm	5.7 mm	7.0 mm	246.0 mm	2
	4.5 mm	6.3 mm	7.0 mm	250.5 mm	2
	5.0 mm	6.7 mm	8.5 mm	268.0 mm	2
	5.5 mm	7.3 mm	12.0 mm	299.0 mm	2
	6.0 mm	8.0 mm	12.0 mm	330.5 mm	2
	6.5 mm	8.7 mm	12.0 mm	331.0 mm	2

* Length without connector

SILKOCLEAR

TRACHEAL TUBE

- nasal/oral (Magill)
- made of silicone
- black tip
- semi-seated connector
- graduated
- latex-free
- sterile



PLEASE NOTE:
SILKOSPRAY is not suitable for devices made of silicone. As a lubricant, we recommend commercially available gels.

SILKOCLEAR

RÜSCH

REF.	ORDER SIZE/I.D.	O.D.	LENGTH*	QTY
100280	2.0 mm	3.3 mm	120 mm	10
	2.5 mm	4.0 mm	140 mm	10
	3.0 mm	4.7 mm	160 mm	10
	3.5 mm	5.3 mm	180 mm	10
	4.0 mm	6.0 mm	200 mm	10
	4.5 mm	6.7 mm	220 mm	10

* Length without connector

ARMoured TRACHEAL TUBES

- nasal/oral
- made of PVC
- mounted connector
- radiopaque
- graduated
- latex-free
- sterile
- single use



ARMoured TRACHEAL TUBES

RÜSCH

REF.	ORDER SIZE/I.D.	O.D.	LENGTH*	QTY
103600	2.5 mm	4.1 mm	184.0 mm	2
	3.0 mm	4.8 mm	184.5 mm	2
	3.5 mm	5.5 mm	184.5 mm	2
	4.0 mm	6.0 mm	194.5 mm	2
	4.5 mm	6.5 mm	198.0 mm	2
	5.0 mm	7.2 mm	208.0 mm	2
	5.5 mm	7.7 mm	208.0 mm	2
	6.0 mm	8.2 mm	208.0 mm	2
	6.5 mm	8.9 mm	268.5 mm	2

* Length without connector

- nasal/oral
- made of silicone
- cupped atraumatic tip
- fixed connector
- radiopaque
- graduated
- latex-free
- sterile



PLEASE NOTE:

SILKOSPRAY is not suitable for devices made of silicone. As a lubricant, we recommend commercially available gels.

ARMoured TRACHEAL TUBES

RÜSCH

REF.	ORDER SIZE/I.D.	O.D.	LENGTH*	QTY
105400	2.0 mm	3.3 mm	223.0 mm	2
	2.5 mm	3.9 mm	224.0 mm	2
	3.0 mm	4.3 mm	225.5 mm	2
	3.5 mm	5.0 mm	226.0 mm	2
	4.0 mm	5.7 mm	246.0 mm	2
	4.5 mm	6.3 mm	250.5 mm	2
	5.0 mm	6.7 mm	263.0 mm	2
	5.5 mm	7.3 mm	294.5 mm	2
	6.0 mm	8.0 mm	326.0 mm	2
	6.5 mm	8.7 mm	327.5 mm	2

* Length without connector

AID ADAPTER SET FOR CPR

AID INSTILLATION CATHETER

Catheter with angled connector for instillation during CPR

- including size: O.D. Ch. 4
- with sealable Luer-lock adapter
- multiple perforations over a length of 1 cm, beginning 1 cm from the patient end of the catheter
- intubation stylet
- graduated
- latex-free
- sterile
- single use

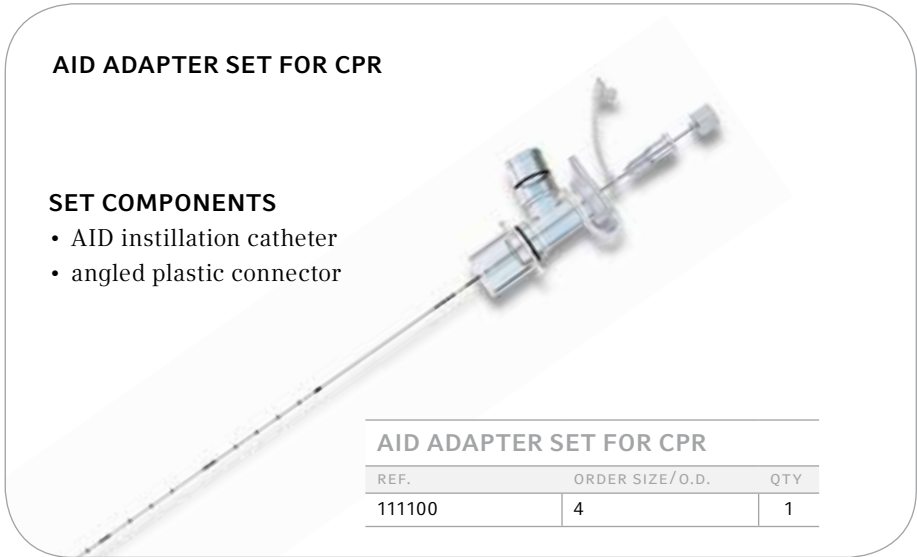

EDGAR TUBE

CLEAR TRACHEAL TUBE MADE OF PVC

For endobronchial drug and gas application during CPR

- nasal/oral (Magill)
- made of clear PVC
- with black tip
- semi-seated connector
- additional instillation channel with sealable Luer-lock adapter
- continuous X-ray marker
- graduated
- latex-free
- sterile
- single use



EDGAR TUBE				RUSCH
REF.	ORDER SIZE/I.D.	O.D.	LENGTH*	QTY
111380	2.5 mm	4.0 mm	140 mm	10
	3.0 mm	4.0 mm	160 mm	10
	3.5 mm	5.3 mm	180 mm	10
	4.0 mm	6.0 mm	200 mm	10
	4.5 mm	6.7 mm	220 mm	10
	5.0 mm	6.7 mm	240 mm	10
	5.5 mm	7.3 mm	270 mm	10
	6.0 mm	8.0 mm	280 mm	10

* Length without connector

LARYNGEAL MASKS

The true benefits of laryngeal masks are firstly that they lead to less pain and coughing than endotracheal tubes, and secondly, that they are much easier to insert. This makes the laryngeal mask ideal for use with children, as it helps to keep them steady during sensitive procedures and

because it is more comfortable. Our Sure Seal range comes with an integrated cuff pressure indicator. This Cuff Pilot constantly monitors the pressure in the cuff and detects changes due to temperature, nitrous oxide levels and movement within the airway.

SURE SEAL

As we care about your patients, we have come up with a comprehensive range of high-quality, finely designed laryngeal masks, to fit all your needs. On top of the unique safety feature that is the Cuff Pilot, our products include many other essential characteristics to answer most of your concerns.

SINGLE USE & REUSABLE

SIZE	I.D.	O.D.	PATIENT WEIGHT	CUFF VOLUME
1	5.3	8	< 5 kg	< 4 ml
1.5	6.1	10	5–10 kg	< 7 ml
2	7.0	11	10–20 kg	< 10 ml
2.5	8.4	13	20–30 kg	< 14 ml
3	10	15	30–50 kg	< 20 ml
4	10	15	50–70 kg	< 30 ml

REINFORCED SINGLE USE & REUSABLE

SIZE	I.D.	O.D.	PATIENT WEIGHT	CUFF VOLUME
1	5	7	< 5 kg	< 4 ml
1.5	5	7	5–10 kg	< 7 ml
2	5.1	9	10–20 kg	< 10 ml
2.5	6.1	10	20–30 kg	< 14 ml
3	7.6	11	30–50 kg	< 20 ml
4	7.6	11	50–70 kg	< 30 ml

LARYNGEAL MASK WITH CUFF PILOT

- integrated cuff pressure monitoring device
- silicone cuff
- epiglottis bars
- black line on the tube for better placement
- 15 mm universal connector
- mask size, patient weight & cuff volume indicated on the tube
- packaging colour-coded
- latex-free, DEHP-free
- sterile
- single use

SURE SEAL WITH CUFF PILOT

REF.	ORDER SIZE	TUBE	CUFF	QTY
105210	1–4	silicone	silicone	10
105200	1–4	PVC	silicone	10
105220	1–4	silicone reinforced	silicone	10



Ref. 105210

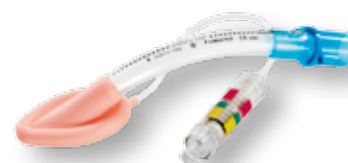

Ref. 105200



Ref. 105220

REUSABLE LARYNGEAL MASK WITH STANDARD PILOT BALLOON

- silicone cuff
- epiglottis bars
- black line on the tube for better placement
- 15 mm universal connector
- mask size, patient weight & cuff volume indicated on the tube
- latex-free, DEHP-free

**SURE SEAL**

REF.	ORDER SIZE	TUBE	CUFF	QTY
105000	1–4	silicone	silicone	10
105010	1–4	silicone reinforced	silicone	10

LARYNGEAL MASK WITH STANDARD PILOT BALLOON

- silicone cuff
- epiglottis bars
- black line on the tube for better placement
- 15 mm universal connector
- mask size, patient weight & cuff volume indicated on the tube
- packaging colour-coded
- latex-free, DEHP-free
- sterile
- single use

**SURE SEAL**

REF.	ORDER SIZE	TUBE	CUFF	QTY
105310	1–4	silicone	silicone	10
105300	1–4	PVC	silicone	10
105320	1–4	silicone reinforced	silicone	10

CRYSTAL AIRWAY MASK

For use in anaesthesia as well as emergency medicine, this supraglottic airway device reduces the potential for trauma to the soft tissue of children. A support wedge between cuff and tube helps to protect against leakage.

- full PVC laryngeal mask
- rotationally-molded cuff
- black line on the tube for better placement
- strong, yet thin soft reinforced posterior wall of the cuff
- inflation channel integrated into the tube
- 15 mm universal connector
- colour-coded acc. to size
- mask size, patient weight & cuff volume indicated on the tube
- latex-free
- sterile
- single use

**CRYSTAL AIRWAY MASK****RUSCH**

REF.	ORDER SIZE	PATIENT WEIGHT	I.D.	O.D.	CUFF MAX. VOL.	COLOUR CODE	QTY
111000	1.0	< 5 kg	6.2 mm	8.6 mm	5 ml	clear	10
	1.5	5–10 kg	7.2 mm	10.0 mm	7 ml	blue	10
	2.0	10–20 kg	8.6 mm	12.0 mm	10 ml	green	10
	2.5	20–30 kg	10.4 mm	14.0 mm	15 ml	purple	10
	3.0	30–50 kg	11.0 mm	16.0 mm	20 ml	orange	10
	4.0	50–70 kg	12.4 mm	18.0 mm	35 ml	pink	10

OROPHARYNGEAL & NASOPHARYNGEAL AIRWAYS

For quick and safe airway patency without intubation, the user can choose from a wide range of RÜSCH oropharyngeal and nasopharyngeal airways. All versions have been specifically developed to suit the child's characteristic requirements and thus represent a safe and adequate solution for most indications. RÜSCH

offers not only standard versions made from a variety of materials but also special models for endoscopies with simultaneous fixations of the tracheal tube. Thanks to the broad selection, these RÜSCH products have become indispensable in many situations in which children need to be treated safely and efficiently.

OROPHARYNGEAL AIRWAYS

OROPHARYNGEAL AIRWAY MADE OF SOFT PVC

- Guedel airway
- clear
- colour-coded
- latex-free
- single use



OROPHARYNGEAL AIRWAY MADE OF SOFT PVC

RÜSCH

REF.	ORDER SIZE	ISO SIZE	COLOUR CODE	QTY
124700	000	3	colourless	10
	00	4	pink	10
	0	5	blue	10
	1	6	black	10
	2	7	white	10
	3	8	green	10
	4	9	yellow	10
5	10	red	10	
6	12	violet	10	

OROPHARYNGEAL AIRWAY MADE OF POLYETHYLENE

- Guedel airway
- colour-coded
- latex-free
- sterile
- single use



OROPHARYNGEAL AIRWAY MADE OF POLYETHYLENE

RÜSCH

REF.	ORDER SIZE	ISO SIZE	COLOUR CODE	QTY
124900	000	3	colourless	10
	00	4	pink	10
	0	5	blue	10
	1	6	black	10
	2	7	white	10
	3	8	green	10
4	9	yellow	10	
5	10	red	10	

OROPHARYNGEAL AIRWAY MADE OF POLYETHYLENE

- Guedel airway
- colour-coded
- latex-free
- non sterile
- single use



OROPHARYNGEAL AIRWAY MADE OF POLYETHYLENE *RUSCH*

REF.	ORDER SIZE	ISO SIZE	COLOUR CODE	QTY
672901	00	4	pink	50
	0	5	blue	50
	1	6	black	50
	2	7	white	50
	3	8	green	50
	4	9	yellow	50
	5	10	red	50

NASOPHARYNGEAL AIRWAYS

NASOPHARYNGEAL AIRWAY

- Wendl pattern
- made of WIRUPREN®
- with adjustable flange
- latex-free
- sterile
- single use

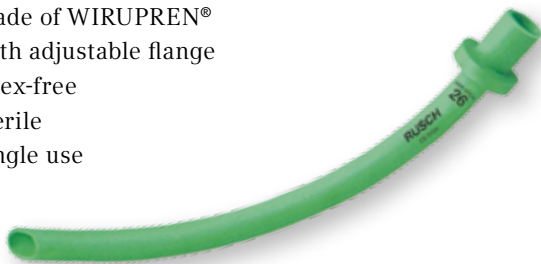

NASOPHARYNGEAL AIRWAY *RUSCH*

REF.	ORDER SIZE	I.D.	O.D.	LENGTH	QTY
185420	12	2.0 mm	4.00 mm	95 mm	5
	14	2.5 mm	4.67 mm	95 mm	5
	16	3.0 mm	5.33 mm	95 mm	5
	18	3.5 mm	6.00 mm	95 mm	5
	20	4.5 mm	6.67 mm	125 mm	5
	22	5.0 mm	7.33 mm	170 mm	5
	24	5.5 mm	8.00 mm	170 mm	5
	26	6.0 mm	8.67 mm	170 mm	5

NASOPHARYNGEAL AIRWAY

- made of PVC
- transparent
- sterile



NASOPHARYNGEAL AIRWAY *RUSCH*

REF.	ORDER SIZE	I.D.	O.D.	LENGTH	QTY
125410	12	2.5 mm	3.97 mm	60 mm	10
	14	3.0 mm	4.64 mm	72 mm	10
	16	3.5 mm	5.30 mm	85 mm	10
	18	4.5 mm	5.97 mm	105 mm	10
	19	4.5 mm	6.29 mm	110 mm	10
	20	5.0 mm	6.63 mm	115 mm	10
	22	5.5 mm	7.29 mm	125 mm	10
	24	6.0 mm	7.96 mm	130 mm	10
	26	6.5 mm	8.63 mm	140 mm	10

NASOPHARYNGEAL AIRWAY

- Wendl pattern
- made of soft rubber
- with adjustable flange

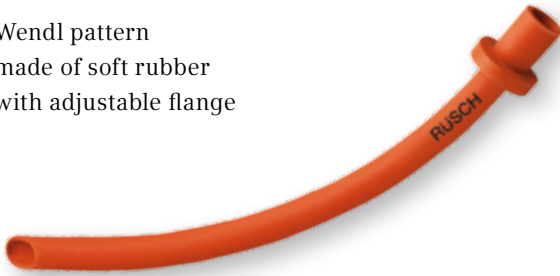

NASOPHARYNGEAL AIRWAY				RUSCH	
REF.	ORDER SIZE	I.D.	O.D.	LENGTH	QTY
125200	12	2.0 mm	4.0 mm	95 mm	5
	14	2.5 mm	4.7 mm	95 mm	5
	16	3.0 mm	5.3 mm	95 mm	5
	18	3.5 mm	6.0 mm	95 mm	5
	20	4.0 mm	6.7 mm	115 mm	5
	22	4.5 mm	7.3 mm	125 mm	5
	24	5.0 mm	8.0 mm	170 mm	5
	26	5.5 mm	8.7 mm	170 mm	5

ANAESTHESIA MASKS/ REBREATHING BAGS

With RUSCH anaesthesia masks and rebreathing bags, we have a long tradition of serving the medical market with tried and tested quality products. Whether made of sili-

cone, Wirupren, rubber or latex, the choice of masks and bags at your disposal meets any requirement. Your paediatric patients can rely on us.

FACE MASKS

SILICONE FACE MASK

- Size 0-2: round, transparent
- Size 3-5: anatomically shaped, non-inflatable
- 22 mm connection
- latex-free



SILICONE MASK		RUSCH	
REF.	SIZE	QTY	
154900	0	2	
	1	2	
	2	2	
	3	2	
	4	2	
	5	2	

BLACK RUBBER FACE MASK

- with hook ring
- inflatable
- 22 mm connection



BLACK RUBBER FACE MASK*		RUSCH	
REF.	SIZE	QTY	
154601-100003	0	1	
154601-100010	1	1	
154601-100020	2	1	
154601-100030	3	1	

*ATTENTION: These products contain natural rubber latex which may cause allergic reactions.

CLEAR COMFORT MASK

- scented
- inflatable
- sizes 1 & 2: 15 mm connector
- size 3: 22 mm connector & 22 mm colour-coded retaining ring, removable for hand-held procedures
- single use



CLEAR COMFORT MASK

REF.	SIZE			QTY
415800	1	Neonate	Baby powder scent – no ring	20
415802	2	Infant	Strawberry scent – no ring	20
415804	3	Child	Bubblegum scent – yellow ring	20

PAEDIATRIC SILICONE FACE MASK

- Rendall-Baker-Souceck pattern
- transparent
- 22 mm connection
- latex-free



PAEDIATRIC SILICONE FACE MASK

RÜSCH

REF.	SIZE	QTY
154300-000003	0	2
154300-000010	1	2
154300-000020	2	2
154300-000030	3	2

PAEDIATRIC BLACK RUBBER FACE MASK*

- Rendall-Baker-Souceck pattern
- 22 mm connection
- size 3 available only with harness ring



PAEDIATRIC BLACK RUBBER FACE MASK*

RÜSCH

REF.	SIZE	QTY
154700-100003	0	1
154700-100010	1	1
154700-100020	2	1
154700-100030	3	1

WIRUPREN PAEDIATRIC FACE MASK

- blue
- inflatable
- 22 mm connection



WIRUPREN PAEDIATRIC FACE MASK

RÜSCH

REF.	SIZE	QTY
154607-000003	0	1
154607-000010	1	1
154607-000020	2	1
154607-000030	3	1

*ATTENTION: These products contain natural rubber latex which may cause allergic reactions.

AIR CUSHION FACE MASKS

The HUDSON RCI colour-coded air cushion masks with anatomically shaped cushions provide a comfortable gas-tight, low-pressure seal. The specially designed nose area prevents irritation and damage to the eyes, and the transparent dome allows continuous assessment of patient status.



- colour-coded retaining rings for easy identification of mask size are removable for handheld procedures; not available individually
- all sizes available with optional inflation port for customised fit and comfort
- standard 22 mm and 15 mm connecting ports assure secure connections and meet ISO standards
- 100% latex-free
- single use

AIR CUSHION FACE MASKS

HUDSON RCI

REF.	DESCRIPTION	CONNECTOR	RING COLOUR	QTY
41271	Neonate	15 mm	white	20
41272	Infant	15 mm	pink	20
41273	Paediatric/Toddler	22 mm	yellow	20

AIR CUSHION FACE MASKS, WITH INFLATION PORT

HUDSON RCI

REF.	DESCRIPTION	CONNECTOR	RING COLOUR	QTY
41277	Neonate	15 mm	white	20
41278	Infant	15 mm	pink	20
41279	Paediatric/Toddler	22 mm	yellow	20

LIFESAVER™ DISPOSABLE RESUSCITATORS

Disposable Lifesaver resuscitators from HUDSON RCI combine quality, features, and performance with the convenience of a disposable product. They are designed to meet or exceed ISO and ASTM standards. The unique right-angle oxygen tubing connector swivels 360°. The paediatric and neonate bags have a built-in pressure relief valve and a pressure monitoring port.

- with mask and flow diverter
- individually packed



LIFESAVER

HUDSON RCI

REF.	DESCRIPTION	QTY
45367	Paediatric / Child	6
45362	Neonate / Infant	6

REBREATHING BAGS



SILKOBAG

RÜSCH

	REF.	ORDER SIZE/VOLUME	DESCRIPTION	QTY
	150700	0.5 l	<ul style="list-style-type: none"> • made of silicone • with loop • 22 mm connection • latex-free 	2
		1.0 l		2
		1.5 l		2
		2.0 l		2
		2.3 l		2
		3.0 l		2

LATEX REBREATHING BAG, BLACK*

RÜSCH

	REF.	ORDER SIZE/VOLUME	DESCRIPTION	QTY
	151300	0.5 l	<ul style="list-style-type: none"> • made of latex • with extended loop • 22 mm connection 	5
		0.75 l		5
		1.0 l		5
		1.5 l		5
		2.0 l		5
		2.3 l		5
		3.0 l		5
		4.0 l		5
		5.0 l		5
		6.0 l		5
	151000	0.5 l	<ul style="list-style-type: none"> • made of latex • with loop • 22 mm connection 	5
		1.0 l		5
		1.5 l		5
		2.0 l		5
		2.3 l		5
		3.0 l		5
		3.5 l		5
		3.5 l		5
	153000	0.5 l	<ul style="list-style-type: none"> • made of latex • with extended closed tube • with loop • 22 mm connection 	5
		1.0 l		5
		1.5 l		5
		2.0 l		5

REBREATHING BAG

RÜSCH

	REF.	ORDER SIZE/VOLUME	DESCRIPTION	QTY
	191670	0.5 l	<ul style="list-style-type: none"> • latex-free • 22 mm connection • single use 	10
		1.0 l		10
		2.0 l		10
		3.0 l		10

*ATTENTION: These products contain natural rubber latex which may cause allergic reactions.

INFANT NASAL PRONG CPAP CANNULAS

Our infant nasal prong CPAP (continuous positive airway pressure) cannula system is designed to reduce trauma associated with the delivery of infant nasal CPAP. The soft, anatomically curved prongs enhance fit and minimise nasal septal necrosis. Two convenient product configurations and 6 sizes are offered to allow optimal comfort and performance. Adjustable right-angle connectors facilitate positioning of tubing and a pressure port allows for the monitoring of proximal airway pressure. HUDSON RCI CPAP cannulas can be used with mechanical ventilators, water seal systems or variable orifice CPAP generators.

CPAP CANNULA SIZES		<i>HUDSON RCI</i>
WEIGHT RANGE	SUGGESTED SIZE	
Less than 700 grams	0	
700 to 1250 grams	1	
1250 to 2000 grams	2	
2000 to 3000 grams	3	
Over 3000 grams	4	
1 to 2 years of age	5	

INFANT NASAL PRONG CPAP CANNULA SYSTEM



SET COMPONENTS

- 1 cannula
- 1 inspiratory and one expiratory elbow
- 2 corrugated tubings, 120 cm length (I.D. 10 mm)
- 1 15 cm pressure monitoring line
- 1 22 mm to 10 mm humidifier adaptor
- 1 knit cap
- 2 15 cm sections of Velcro securing tape

REF.	SIZE	QTY
41683	0	10
41685	1	10
41686	2	10
41687	3	10
41688	4	10
41689	5	10

INFANT NASAL PRONG CPAP CANNULA SYSTEM



SET COMPONENTS

- 1 cannula
- 1 inspiratory and one expiratory elbow
- 2 10 mm to 7.5 mm adaptors
- 1 knit cap
- 2 15 cm sections of Velcro securing tape

REF.	SIZE	QTY
41690	0	10
41691	1	10
41692	2	10
41693	3	10
41694	4	10
41695	5	10

CIRCUITS

The Teleflex range also covers the full spectrum of circuits for airway needs and ventilation. Circuits are available in a variety of configurations, materials and styles, catering for the particular anatomy of neonates, infants, children and adults. While the RÜSCH Anaesthesia Set Ulm pattern

can be attached to all adult closed-circuit systems, the heated-wire circuits from HUDSON RCI are specifically designed for use with our ConchaTherm IV and Neptune heated humidification systems. Disposable circuits render procedures convenient and economic.

ANAESTHESIA SET, ULM PATTERN

This set can be quickly and easily attached to all adult closed-circuit systems. The set has minimum dead space and low expiratory resistance.

- made of silicone
- sterile

ANAESTHESIA SET, ULM PATTERN

SET COMPONENTS

- 2 corrugated tubes (Ref. 158902) 110 cm, I.D. 9.5 mm with mounted standard connectors (Ref. 501063)
- 1 corrugated tube 110 cm (Ref. 158903)
- 1 rebreathing bag 0.5 l (Ref. 150700)
- 1 Y-connector (Ref. 514100)
- 1 angled connector (Ref. 514200)
- 1 connector (Ref. 514300)
- 1 connector extracting key

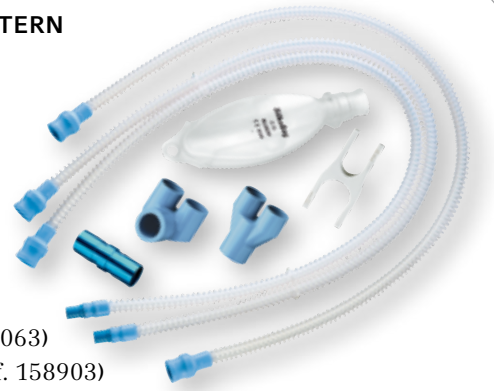

REF.	QTY
159468	1

CIRCUITS WITH TWO LIMBS

CORRUGATED BREATHING CIRCUITS

RUSCH

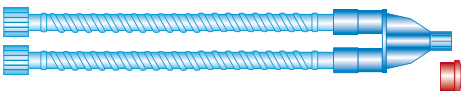
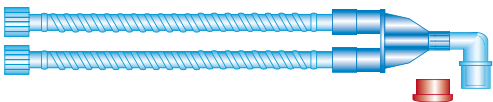
	REF.	DESCRIPTION	LENGTH	QTY
	191785-529150	<ul style="list-style-type: none"> • Ø 15 mm • 22F-22M/15F • available in various lengths • Y connector with cap • made of polyethylene • single use 	150 cm	10
	191785-532120	<ul style="list-style-type: none"> • Ø 15 mm • 22F-22M/15F • available in various lengths • Y connector with cap • angled connector • made of polyethylene • single use 	120 cm	10
	191785-532150		150 cm	10

SMOOTHBORE BREATHING CIRCUITS

RUSCH

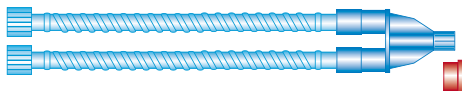
	REF.	DESCRIPTION	LENGTH	QTY
	191785-542120	• Ø 15 mm	120 cm	10
	191785-542150	• 22F-22M/15F	150 cm	10
	191785-542180	• available in various lengths	180 cm	10
	191785-542240	• Y connector with cap • made of DEHP-free PVC	240 cm	10
	191785-544150	• angled connector, Ref. 191785-544150 • single use	150 cm	10

SMOOTHBORE BREATHING CIRCUITS – NEONATES

RUSCH

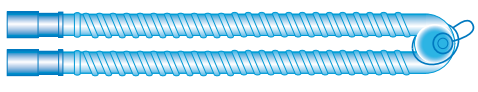
	REF.	DESCRIPTION	LENGTH	QTY
	191568-001200	• made of DEHP-free PVC	120 cm	10
	191568-001500	• 15 F and 22 F connector	150 cm	10
	191568-001800	• Ø 10 mm • with U-connector • sterile • single use	180 cm	10

CIRCUITS WITH ONE WATERTRAP

BREATHING CIRCUITS Ø 15 MM

RUSCH

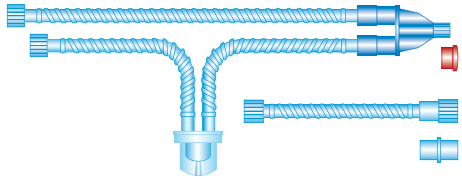
	REF.	DESCRIPTION	LENGTH	QTY
	191785-537160	• made of DEHP-free PVC	160 cm	10
	191785-537180	• smoothbore	180 cm	10
	191785-537200	• 22M-22M connector • Y connector with cap • additional tubing 80 cm • single use	200 cm	10
	191785-552150	• made of polyethylene	150 cm	10
	191785-552200	• corrugated • 22M-22M connector • Y connector with cap • additional tubing 80 cm • single use	200 cm	10

CIRCUITS WITH TWO WATERTRAPS

BREATHING CIRCUITS Ø 15 MM

RUSCH

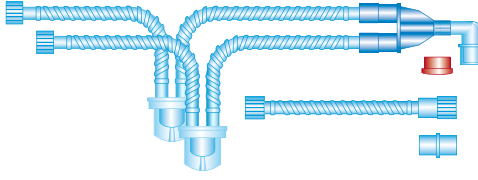
	REF.	DESCRIPTION	LENGTH	QTY
	191785-539160	• made of DEHP-free PVC	160 cm	10
	191785-539180	• smoothbore	180 cm	10
	191785-539200	• 22M-22M connector	200 cm	10
	191785-539240	• Y connector with cap • angled connector • additional tubing 80 cm • single use	240 cm	10
	191785-556160	• made of polyethylene	160 cm	10
	191785-556200	• corrugated	200 cm	10
	191785-556240	• 22M-22M connector • Y connector with cap • angled connector • additional tubing 80 cm • single use	240 cm	10

UNIVERSAL NEONATAL VENTILATOR CIRCUIT

HUDSON RCI

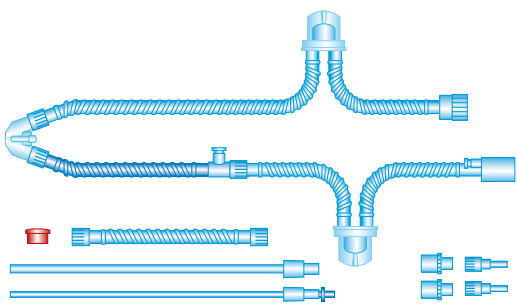
	REF.	SIZE	DESCRIPTION	LENGTH	QTY
	780-12	2	<ul style="list-style-type: none"> made of polyethylene lightweight Ø 10 mm corrugated 45 cm remote temperature port humidifier limb single use 	120 cm	20

INTENSIVE CARE PAEDIATRIC

RUSCH

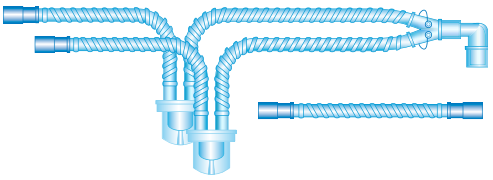
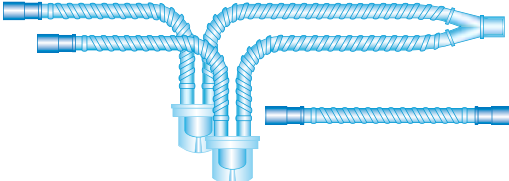
	REF.	DESCRIPTION	CONFIGURATION	LENGTH	QTY
	191138-001200	<ul style="list-style-type: none"> made of DEHP-free PVC smoothbore 	4 tubes of 60 cm each	120 cm	1
	191138-001500	<ul style="list-style-type: none"> 22M/F and 22F connector 	4 tubes of 75 cm each	150 cm	1
	191138-001600	<ul style="list-style-type: none"> with elbow connector 	4 tubes of 80 cm each	160 cm	1
	191138-001800	<ul style="list-style-type: none"> Ø 15 mm with Y-piece with CO₂ and temperature port additional tubing 60 cm long sterile single use 	4 tubes of 90 cm each	180 cm	1
	191685-001500	<ul style="list-style-type: none"> made of DEHP-free PVC smoothbore 22M/F and 22F connector Ø 15 mm with Y-piece additional tubing 60 cm long sterile single use 	4 tubes of 75 cm each	150 cm	1

INTENSIVE CARE AND PAEDIATRIC

RUSCH

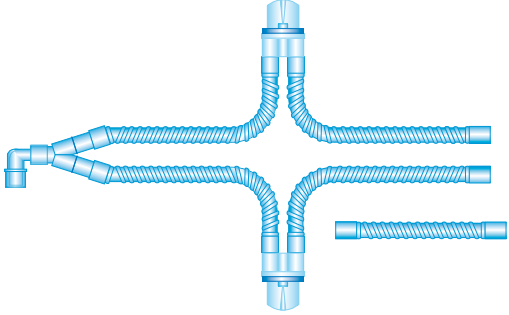
	REF.	DESCRIPTION	LENGTH	QTY
	191234-001200	<ul style="list-style-type: none"> paediatric 	120 cm	10
	191234-001500	<ul style="list-style-type: none"> made of DEHP-free PVC smoothbore two 22F connectors Ø 15 mm Y-connector temperature and CO₂ port non sterile single use 	150 cm	10

DISPOSABLE CIRCUITS FOR ANAESTHESIA

HUDSON RCI disposable circuits for anaesthesia and accessory components offer cost-effective convenience and flexibility. Our high-quality standard circuit configurations include universally required components. All circuits and connectors meet ISO and ASTM standards.

DISPOSABLE CIRCUIT FOR ANAESTHESIA

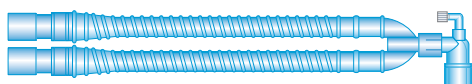

SET COMPONENTS

- corrugated tubing, 150 cm
- 15 mm fixed paediatric wye with gas sampling port
- 15 mm x 22 mm machine cuffs
- single use

REF.	LENGTH	QTY
353900	150 cm	20

DISPOSABLE CIRCUIT FOR ANAESTHESIA

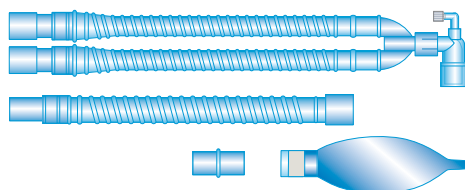

SET COMPONENTS

- corrugated tubing, 150 cm
- 15 mm fixed paediatric wye with gas sampling port
- 15 mm x 22 mm machine cuffs
- 22M-22M adaptor
- 100 cm extension hose
- 1 breathing bag (1 l)
- single use

REF.	LENGTH	QTY
313901	150 cm	20

DOUBLE D®

COAXIAL BREATHING CIRCUIT

One tube – two functions: our Double D coaxial breathing circuit includes both the inspiratory as well as the expiratory limb in one tube. The two limbs share a common wall, which results in a transfer of heat. The inspiratory gases are then automatically warmed by the expiratory gases passing in the expiratory limb. This allows the child to be optimally ventilated at all times.

- full system weight: < 250 g
- thermal efficiency: 4.1°C*
- compliance at 100 cm H₂O per metre of tube length: 1.1 ml/cm H₂O**
- elbow connector
- LL-port for capnometry
- clean

* at 10 L/min flow rate within the first 20 minutes (net temperature increase)

** measurement performed per ISO 5367 at a pressure of 100 cm H₂O

DOUBLE D



SET COMPONENTS



- Double D breathing circuit
- additional tubing (only Ref. 198886-001800, 198886-001801)
- 2-litre latex-free breathing bags

REF.	LENGTH	ADDITIONAL TUBING	QTY
198881-001800	180 cm	–	20
198886-001800	180 cm	120 cm	20
198886-001801	180 cm	150 cm	20
198881-002800	280 cm	–	20
198886-031800	180 cm	300 cm	20
198886-032800	280 cm	300 cm	20

TUBING MADE OF SILICONE

Just like our rebreathing bags, all RÜSCH tubing is equipped with the Safety Lip System and has standardised nozzles. Especially ergonomic: The RÜSCH Ergogrip system facilitates the disconnection of the tubing from the machine.

- corrugated
- I.D. 9.5 mm
- nozzles with safety lip system

TUBING MADE OF SILICONE				RÜSCH	
	REF.	DESCRIPTION	LENGTH	QTY	
	158900	with nozzle at both ends to fit 10 mm connection	20 cm	1	
			30 cm	1	
			45 cm	1	
			60 cm	1	
			85 cm	1	
			110 cm	1	
	158902	with nozzle to fit 10 mm and 22 mm connection	110 cm	1	
	158903	with nozzle at both ends to fit 22 mm connection	110 cm	1	

SMOOTHBORE TUBING

SMOOTHBORE TUBING FOR CHILDREN

RÜSCH

	REF.	DESCRIPTION	LENGTH	QTY
	191209-001500	<ul style="list-style-type: none"> • I.D. 15 mm • 22 F-22 F connector 	150 cm	25
	191209-001800		180 cm	25

SMOOTHBORE TUBING FOR NEONATES

RÜSCH

	REF.	DESCRIPTION	STERILE OR CLEAN	LENGTH	QTY
	191785-000060	<ul style="list-style-type: none"> • I.D. 10 mm 		60 cm	10
	191785-500180			180 cm	10

CATHETER MOUNTS

RÜSCH offers a broad range of catheter mounts. Each individual tube can be supplemented by elbow connectors for aspiration, bronchoscopy or capnography. Premounted sets of elbow connectors, filters and catheter mounts save

time and optimise procedures. For us, safety and comfort are always of the highest priority, especially when it comes to paediatric patients.

EXPANDABLE TYPE FLEXTUBE

- adjustable length
- memory shape
- minimises dead space at bedside
- little storage space required
- resistant to kinking



EXPANDABLE CATHETER MOUNT WITH STRAIGHT CONNECTOR

RÜSCH

	REF.	MACHINE-SIDE CONNECTOR	STERILE OR CLEAN	LENGTH	QTY
	191045	15M	sterile	9–15 cm	25
	191039	15M	clean	9–15 cm	25
	191041	22F	sterile	9–15 cm	25
	191040	22F	clean	9–15 cm	25

EXPANDABLE CATHETER MOUNT WITH DOUBLE SWIVEL CONNECTOR

SEAL-AROUND 9 MM CAP FOR FIBRE-OPTIC BRONCHOSCOPY AND 3.5 PORT FOR SUCTIONING. IDEAL FOR INTENSIVE CARE UNIT.

RÜSCH

	REF.	MACHINE-SIDE CONNECTOR	STERILE OR CLEAN	LENGTH	QTY
	191033	15M	sterile	9–15 cm	25
	191034	15M	clean	9–15 cm	25
	191037	22F	sterile	9–15 cm	25
	191036	22F	clean	9–15 cm	25

All expandable tube lengths are from 9 cm not expanded to 15 cm fully expanded.

ACCESSORIES

Teleflex provides a large range of accessories to complement our instruments for paediatric airway management. These include different intubation stylets, various adaptors and tubing, as well as the Endoguide-T tube

exchanger and insertion aid, the Endotest cuff pressure filling and monitoring device, and a universal silicone spray. With everything available from one source, you can save time and costs.



ENDOGUIDE-T

RUSCH

REF.	ORDER SIZE	DESCRIPTION	I.D.**	O.D.	LENGTH*	QTY
503100	2.5	Tube exchanger and insertion aid in one <ul style="list-style-type: none"> • permanently available large lumen for constant oxygenation of the patient • connection system for 15 mm connectors and Luer-lock connections • depth markers • instructions for use on the instrument • latex-free • single use 	1.4 mm	2.6 mm	700 mm	1
	6.0		3.2 mm	5.0 mm	800 mm	1

* Length without connector ** I.D. 1.4 mm to be used with tracheal tubes size I.D. 3.0 – 6.0 mm, I.D. 3.2 mm to be used with tracheal tubes size I.D. 6.5 – 11 mm



INTUBATION STYLET MADE OF PVC

RUSCH

REF.	ORDER SIZE	DESCRIPTION	FOR I.D.	O.D.	LENGTH APPROX.	QTY
503000	15	<ul style="list-style-type: none"> • for tracheal tubes • flexible • cupped, soft tip • latex-free 	2.0–2.5 mm	1.5 mm	350 mm	10
	20		2.5–3.0 mm	2.0 mm	400 mm	10
	26		3.0–3.5 mm	2.6 mm	400 mm	10
	33		3.5–4.5 mm	3.3 mm	450 mm	10
	43		4.5–6.0 mm	4.3 mm	450 mm	10
	56		from 6.0 mm	5.6 mm	500 mm	10

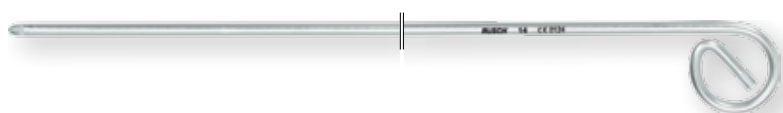

FLEXISLIP INTUBATION STYLET

RUSCH

REF.	ORDER SIZE	DESCRIPTION	FROM I.D.	O.D.	LENGTH CURVED	QTY
503700	6	<ul style="list-style-type: none"> • for tracheal tubes • cupped tip • curved handle • flexible metal stylet with plastic coating • smooth Safety Silk surface • latex-free • sterile 	2.5 mm	1.95 mm	22 mm	20
	10		3.5 mm	3.30 mm	34 mm	20
	12		4.0 mm	3.94 mm	37 mm	20
	14		5.0 mm	4.60 mm	37 mm	20



UNIVERSAL ADAPTER, MAINZ PATTERN, MADE OF PLASTIC

RÜSCH

	REF.	DESCRIPTION	SIZES I.D./O.D.	QTY
	514805	<ul style="list-style-type: none"> • for fiberoptic intubation during simultaneous mask ventilation • connector for face masks, tracheal tubes and laryngeal masks • lateral connector for anaesthetic circuit • double sealing cap made of silicone • sterile 	O.D. 15 mm + O.D. 22 mm / I.D. 15 mm	5

Y-CONNECTORS MADE OF PLASTIC

RÜSCH

	REF.	DESCRIPTION	SIZES I.D./O.D.	QTY
	514100	Y-connector <ul style="list-style-type: none"> • dead space without connectors 3.0 ml, with connectors <0.6 ml • latex-free 	2 x I.D. 15 mm 1 x O.D. 22 / I.D. 15 mm	1
	514200	elbow connector <ul style="list-style-type: none"> • dead space without connectors 5.0 ml, with connectors 2.4 ml • latex-free 	2 x I.D. 15 mm 1 x O.D. 22 / I.D. 15 mm	1

STANDARD CONNECTOR

RÜSCH

	REF.	DESCRIPTION	SIZES I.D./O.D.	QTY
	501003	standard connector <ul style="list-style-type: none"> • latex-free 	I.D. 1.5–11.0 mm	10

ENDOTEST

RÜSCH

	REF.	DESCRIPTION	QTY
	112700	Device for filling and monitoring the pressure of low-pressure cuffs on tracheal, tracheostomy and bronchial tubes and laryngeal masks <ul style="list-style-type: none"> • with connecting tube 	1
	230100	Connecting tube made of PVC for ENDOTEST cuff pressure monitoring device <ul style="list-style-type: none"> • transparent, latex-free, with Luer adapter (male and female) • approx. 100 cm long, 2.0 x 3.0 mm 	10

SILKOSPRAY

RÜSCH

	REF.	DESCRIPTION	QTY
	556000	<ul style="list-style-type: none"> • universal silicone spray • prevents incrustation of rubber, latex and PVC devices and also prevents them from sticking to the mucosa • CFC-free • please note: SILKOSPRAY is not suitable for devices made of silicone • for silicone products, we recommend our water soluble lubricating gel TrachJell 	10

TRACHJELL

	REF.	DESCRIPTION	QTY
	556100	<ul style="list-style-type: none"> • single dose water-soluble lubricating gel • 8.5 g • sterile 	25

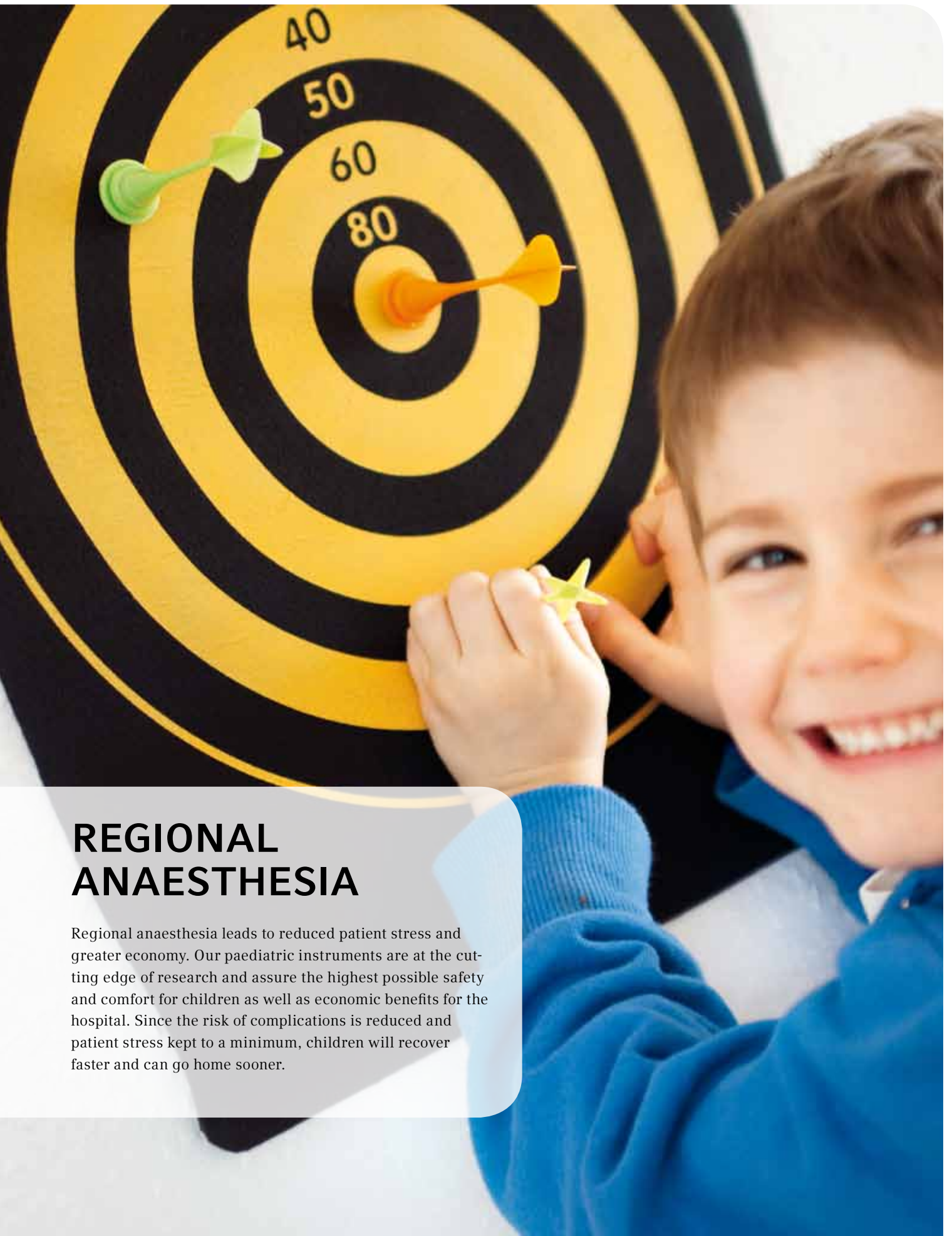

REGIONAL ANAESTHESIA

Regional anaesthesia leads to reduced patient stress and greater economy. Our paediatric instruments are at the cutting edge of research and assure the highest possible safety and comfort for children as well as economic benefits for the hospital. Since the risk of complications is reduced and patient stress kept to a minimum, children will recover faster and can go home sooner.

FLEXTIP PLUS

EPIDURAL CATHETERS

Our FlexTip Plus epidural catheters have been designed to reduce complications for children in the epidural space (caudal and lumbar procedures). Excellent kink-resistance and tensile strength coupled with a soft, flexible tip reduce the risk of paraesthesia as well as the inadvertent penetration of blood vessels or the dura that can misdirect the delivery of anaesthetics.

The catheter's unique coil-reinforced body facilitates simpler and faster epidural procedures. In addition, the structural integrity of this particular design provides resistance to collapsing, so that no stylet is required for insertion (with the exception of caudal procedures in children). An inner reinforced stainless-steel coil body construction enhances catheter radiopacity.



FLEXTIP PLUS EPIDURAL CATHETER, CAUDAL

- Epidural needle Crawford 18 Ga. 4.45 cm
- FlexTip Plus catheter 20 Ga. 90 cm with stylet
- SnapLock adapter
- Flat filter 0.22 µ
- 10 ml LOR syringe

REF.	QTY
EC-05420-P	20

FLEXTIP PLUS EPIDURAL CATHETER, LUMBAR

- Epidural needle Tuohy 18 Ga. 4.45 cm
- FlexTip Plus Catheter 20 Ga. 90 cm
- SnapLock adapter
- Flat filter 0.22 µ
- 10 ml LOR syringe

REF.	QTY
EC-05520-P	20

STIMUQUIK PNB

SINGLE SHOT NEEDLE

Peripheral nerve block anaesthesia has been made easy and safe with our StimuQuik system. It is easy to use and increases overall block success.

The StimuQuik improves the accuracy of single-shot peripheral anaesthesia delivery by enhancing control and manoeuvrability during needle positioning. Two short PNB single-shot needles provide excellent nerve block success in children. In addition, the StimuQuik has been designed with a B-bevel needle tip, which is less traumatic and guarantees optimal penetration.

- insulated needle shaft
- stimulating tip
- clear and easy-to-read cm markings on needle shaft
- ergonomic needle hub for precision grip
- extended length of injection tubing and electrical lead connections
- sterile
- single use

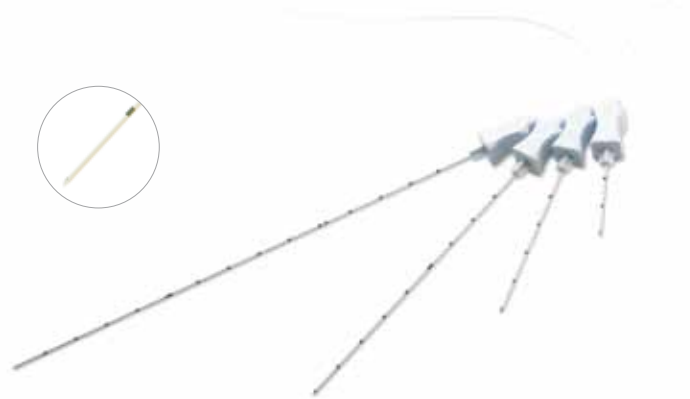

STIMUQUIK PNB SINGLE SHOT NEEDLE		ARROW
REF.	DESCRIPTION	QTY
AB-22025-SS	Single shot needle with extension lines 22 Ga. 2.5 cm	25
AB-22050-SS	Single shot needle with extension lines 22 Ga. 5 cm	25

UROLOGY

Continuous research and development coupled with the use of new technologies has resulted in medical products the quality of which sets the standard throughout the world. Our range of urological products for paediatric care features high-quality instruments for almost any application, and thus enables you to cater optimally for your young patients. The manufacturing processes of our products for paediatric use are carefully monitored to ensure the highest possible standards of quality and safety. Particular attention is paid to tips and eyes to make sure they are completely atraumataical.

With our broad range of catheters and stents you can cater for all indications and situations.

FOLEYS

Thanks to RÜSCH's 125 years of experience in urology, we can proudly claim that amongst others our Foley catheters for transurethral drainage ensure the best possible care for paediatric patients at all times, while remaining cost-effective. Each catheter is manufactured with particular care: all tips and eyes are round and smooth, thin-walled

balloons optimally fit the anatomy of a child's bladder outlet, the material used is of the highest quality. Even for short-term use, only 100 % silicone should be used to avoid sensitising children and provoking allergies. The greatest possible safety and comfort, coupled with ease of handling guarantee optimal care for children.

AQUAFLATE GLYCERINE

- made of silicone, transparent
- with prefilled syringe for balloon inflation
- prefilled syringe in sterile packaging (1.5, 3 or 5 ml sterile 10 % glycerine solution)
- valve for Luer and Luer-lock syringe tips
- radiopaque tip and contrast stripe
- latex-free
- sterile
- single use



AQUAFLATE GLYCERINE, CYLINDRICAL, WITH STYLET, SOLID TIP

RÜSCH

	REF.	ORDER SIZE	BALLOON	EYES	LENGTH (APPROX.)	QTY
	178003-000060	Ch. 6	1.5 ml	2 opposing eyes	31 cm	5
	178003-000080	Ch. 8	3 ml	2 opposing eyes	31 cm	5
	178003-000100	Ch. 10	5 ml	2 opposing eyes	31 cm	5

AQUAFLATE GLYCERINE, TIEMANN, WITH STYLET

RÜSCH

	REF.	ORDER SIZE	BALLOON	EYES	LENGTH (APPROX.)	QTY
	178004-000080	Ch. 8	3 ml	1 eye	31 cm	5
	178004-000100	Ch. 10	5 ml	1 eye	31 cm	5

RÜSCH BRILLANT

- made of silicone, transparent
- valve for Luer and Luer-lock syringe tips
- radiopaque tip and contrast stripe
- latex-free
- sterile
- single use



RÜSCH BRILLANT, CYLINDRICAL, WITH STYLET, SOLID TIP

RÜSCH

	REF.	ORDER SIZE	BALLOON	EYES	LENGTH (APPROX.)	QTY
	170003-000060	Ch. 6	1.5 ml	2 opposing eyes	31 cm	5
	170003-000080	Ch. 8	3 ml	2 opposing eyes	31 cm	5
	170003-000100	Ch. 10	5 ml	2 opposing eyes	31 cm	5

RÜSCH BRILLANT, TIEMANN, WITH STYLET

RÜSCH

	REF.	ORDER SIZE	BALLOON	EYES	LENGTH (APPROX.)	QTY
	170004-000080	Ch. 8	3 ml	1 eye	31 cm	5
	170004-000100	Ch. 10	5 ml	1 eye	31 cm	5

RÜSCH GOLD

- made of latex, yellow
- 2 opposing eyes
- valve for Luer and Luer-lock syringe tips
- for short-term drainage
- siliconised
- sterile
- single use



RÜSCH GOLD, CYLINDRICAL, WITH STYLET

RÜSCH

	REF.	ORDER SIZE	BALLOON	EYES	LENGTH (APPROX.)	QTY
	180003-000080*	Ch. 8	3 ml	2 opposing eyes	30 cm	10
	180003-000100*	Ch. 10	3 ml	2 opposing eyes	30 cm	10

* These products contain natural rubber latex which may cause allergic reactions.

WIRUTHAN® BALLOON CATHETER

- made of polyurethane, transparent
- 1 eye
- latex Rüscher Gold balloon
- valve for Luer and Luer-lock syringe tips
- sterile
- single use



WIRUTHAN BALLOON CATHETER, CYLINDRICAL

RÜSCH

	REF.	ORDER SIZE	BALLOON	EYES	LENGTH (APPROX.)	QTY
	331505-000060*	Ch. 6	3 ml	1 eye	25 cm	5
	331505-000080*	Ch. 8	3 ml	1 eye	25 cm	5
	331505-000100*	Ch. 10	5 ml	1 eye	25 cm	5

* These products contain natural rubber latex which may cause allergic reactions.

SUPRAPUBIC CATHETERS

Our suprapubic urine drainage systems for children with specially designed catheters perfectly complement each other and guarantee quick and safe work. Used for suprapubic drainage or following surgery, they provide a well-tolerated alternative to transurethral drainage. While minimising the risk of infection, they enable simple and

safe handling and the greatest possible comfort during wear in short, medium and long-term medical care. All sets are equipped with colour-coded catheters and puncture needles to eliminate confusion.

EASYCYST INFANT

THE ECONOMICAL CATHETER MADE OF POLYURETHANE FOR SHORT AND MEDIUM-TERM CARE OF CHILDREN

- good drainage capacity even with small outer diameters due to minimum wall thickness
- good compatibility due to low encrustation tendency
- minimum irritation of the bladder mucosa due to the pigtail tip in the bladder
- reduced invasiveness due to the small outer diameter (no balloon)
- safe attachment by suture without significant constriction of the lumen due to shape-retaining polyurethane
- latex-free
- sterile
- single use



EASYCYST INFANT PUNCTURE SET

- EasyCyst Infant pigtail catheter made of polyurethane, length 500 mm
- easily splittable puncture cannula, length 70 mm
- adhesive tape
- clamp

REF.	ORDER SIZE	QTY
170723-000050	Ch. 5	5

EASYCYST INFANT EXCHANGE SET

- EasyCyst Infant pigtail catheter made of polyurethane, length 500 mm
- guidewire with PTFE coating, length 1 000 mm
- adhesive tape
- clamp

REF.	ORDER SIZE	QTY
170722-000050	Ch. 5	5

SUPRACATH



THE ECONOMICAL PRODUCT

MADE OF SILICONE FOR LONG-TERM CARE

- balloon catheter with centrally open, short, straight tip
- high drainage capacity even during long-term care due to extremely low encrustation tendency
- greatest possible comfort during wear thanks to elasticity and biological compatibility
- exceptionally simple and quick catheter change via a guidewire due to the centrally open, straight tip
- no suture necessary as secured by the balloon: minimally invasive
- latex-free
- sterile
- single use

SUPRACATH CATHETER				<i>RÜSCH</i>	
REF.	ORDER SIZE	BALLOON CAPACITY	COLOUR CODE	QTY	
170606	Ch. 8	≈ 3 ml	grey	10	
	Ch. 10	≈ 3–5 ml	black	10	

SUPRACATH PUNCTURE SET

- SupraCath balloon catheter made of silicone, length 410 mm
- 2 000 ml urine bag with non-reflux valve, T-tap outlet and 90 cm inlet tubing
- easily splittable puncture cannula, length 120 mm
- scalpel
- adhesive tape
- plug

REF.	ORDER SIZE	QTY
170727-000080	Ch. 8	5
170727-000100	Ch. 10	5

SUPRACATH EXCHANGE SET

- SupraCath balloon catheter made of silicone, length 410 mm
- guidewire with PTFE coating, length 1 000 mm
- adhesive tape
- plug

REF.	ORDER SIZE	QTY
170729-000080	Ch. 8	5
170729-000100	Ch. 10	5

SUPRAFLEX INFANT



THE LONG-TERM CATHETER FOR CHILDREN, MADE OF SILICONE WITH THE GREATEST POSSIBLE COMFORT DURING WEAR

- extremely high drainage capacity even during long-term usage thanks to low encrustation tendency and large drainage eyes on the inner side of the pigtail
- greatest possible comfort during wear due to constant diameter and biological compatibility
- minimal irritation of the bladder mucosa because of the pigtail tip in the bladder
- latex-free
- sterile
- single use

SUPRAFLEX INFANT PUNCTURE SET

- SupraFlex Infant pigtail catheter made of silicone, length 480 mm
- 2 000 ml urine bag with non-reflux valve, T-tap outlet and 90 cm inlet tubing
- easily splittable puncture cannula, length 80 mm (size Ch. 8) or 120 mm (size Ch. 10)
- scalpel
- adhesive tape
- clamp

REF.	ORDER SIZE	QTY
170702-000080	Ch. 8	5
170702-000100	Ch. 10	5

SUPRAFLEX



THE LONG-TERM CATHETER MADE OF SILICONE WITH THE GREATEST POSSIBLE COMFORT DURING WEAR

- extremely high drainage capacity even during long-term usage thanks to low encrustation tendency and large drainage eyes on the inner side of the pigtail
- greatest possible comfort during wear due to elasticity and biological compatibility
- minimal irritation of the bladder mucosa because of the pigtail tip in the bladder
- no suture necessary as secured by the balloon: minimally invasive
- latex-free
- sterile
- single use

SUPRAFLEX PUNCTURE SET

- SupraFlex pigtail catheter with balloon (≈ 3–5 ml) made of silicone, length 510 mm
- 2 000 ml urine bag with non-reflux valve, T-tap outlet and 90 cm inlet tubing
- easily splittable puncture cannula, length 120 mm
- scalpel
- adhesive tape
- plug

REF.	ORDER SIZE	QTY
170703-000100	Ch. 10	5

SUPRAFLEX EXCHANGE SET

- SupraFlex pigtail catheter with balloon (≈ 3–5 ml) made of silicone, length 510 mm
- guidewire with PTFE coating, length 1 000 mm
- adhesive tape
- plug

REF.	ORDER SIZE	QTY
170704-000100	Ch. 10	5

SILFLATE

PREFILLED SYRINGE WITH STERILE 10% AQUEOUS GLYCERINE SOLUTION FOR INFLATION OF THE BALLOON

- sterile
- single use

Attention: To inflate silicone balloons only!
Do not use for injection!



SILFLATE		RÜSCH
REF.	FILL VOLUME	QTY
850550-000100	10 ml	10

URINE COLLECTORS

With high-quality, economic and innovative products, Teleflex is improving the quality of life of our small urinary drainage patients and providing them with maximum protection against nosocomial urinary tract infections. This is very important for children, as they are more delicate and react more sensitively than adults.

As about 90 % of all nosocomial urinary tract infections are caused by conventional urinary drainage, our closed urinary drainage system, which meets all the hygienic demands made on long-term medical care, represents the first and most important prophylactic measure.

P-BAG

CLOSED URINARY DRAINAGE SYSTEM FOR CHILDREN, FOR STANDARD DRAINAGE UNDER LONG-TERM CONDITIONS

Urine collector with a capacity of 1000 ml and clear graduation in ml

- ridged universal connector with protective cap, suitable for all common catheters
- needle-free urine sampling port at the ridged universal connector
- flexible and kink-resistant tube with sliding clamp and sheet clip
- optimally centred fixation with double hook and additional cord
- vented drip chamber with integrated non-reflux valve, prevents the reflux of urine as well as intraluminally ascending infections
- additional bacteria-proof and liquid-tight ventilation at the bag
- non-dripping bottom outlet with doghouse holder to fix the outlet tube
- latex-free
- sterile
- single use



P-BAG

RÜSCH

REF.	CAPACITY	LENGTH OF TUBE	QTY
673052	1,000 ml	90 cm	20

URETERAL STENTS

With many years of experience in the development of small ureteral stents, we can offer you a range of paediatric stents that reduce the stress on children suffering from the strains of renal pelvis drainage. The optimised relationship between inner and outer diameters enables excellent drainage performance and the highest wearing

comfort. Our stents are made of high-grade, biocompatible and bio-stable polyurethane, which minimises tissue irritation and encrustation. In addition, polyurethane retains its shape extremely well, yet remains flexible at the same time, thus enabling easy and safe placement, secure retention and high patient comfort over a long period.

ANTIREFLUX DD VALVE URETERAL STENT

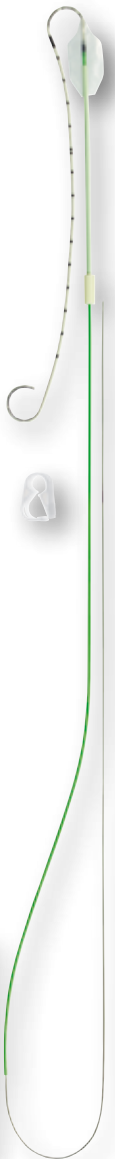

- made of polyurethane
- with DD coupling and antireflux valve at the vesical end
- fully directable
- cm graduations
- completely radiopaque
- pigtail and drainage eyes as indicated in the table
- supplied as a preassembled unit
- flexible guidewire made of stainless steel with PTFE coating, with movable core, approx. 100 cm long in sets with cylindrical closed tip, approx. 150 cm long in sets with tip with central opening
- latex-free
- sterile
- single use

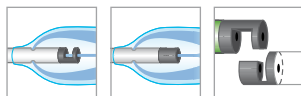

Maximum diameter of guidewire for paediatric antireflux DD valve ureteral stents with central opening

SET COMPONENTS

- ureteral stent
- fixation clamp
- introducer made of polyurethane, green, approx. 45 cm long, with DD coupling
- flexible guidewire
- sets for coaxial application include an additional ureteral catheter with central opening in splint size (see table)
- patient card
- documentation label
- sterile packaging

REF. 335413 / 335414 / 335415
REF. 335416 / 335417

4.8 Ch.

0.028"

ANTIREFLUX DD VALVE URETERAL STENT

RÜSCH

TIP & EYE CONFIGURATION	REF. ACCORDING TO LENGTH OF STRAIGHT PART						ORDER SIZE	QTY
	10 CM	12 CM	15 CM	18 CM	20 CM	22 CM		
cylindrical closed	FOR SIMULTANEOUS APPLICATIONS							
	335315	335309	335314	335310	335313	335312	4.8 Ch.	2
central opening	FOR COAXIAL APPLICATIONS							
	-	335413	335414	335415	335416	335417	4.8 Ch.	2

ANTIREFLUX VALVE URETERAL STENT



- made of polyurethane
- with antireflux valve at the vesical end
- cm graduations
- completely radiopaque
- pigtail and drainage eyes as indicated in the table
- flexible guidewire made of stainless steel with PTFE coating, with fixed core, flexible safety tip and rigid tip, approx. 100 cm long in sets with cylindrical closed tip, approx. 150 cm long in sets with tip with central opening
- latex-free
- sterile
- single use

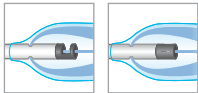

Maximum diameter of guidewire for paediatric antireflux valve ureteral stents with central opening

REF. 335403 / 335404 / 335405	
REF. 335406 / 335407	
3 Ch.	4 Ch.
0.018"	0.018"

SET COMPONENTS

- ureteral stent
- 2 fixation clamps
- introducer made of polyurethane, green, approx. 45 cm long
- flexible guidewire
- sets for coaxial application include an additional ureteral catheter with central opening in splint size (see table)
- patient card
- documentation label
- sterile packaging

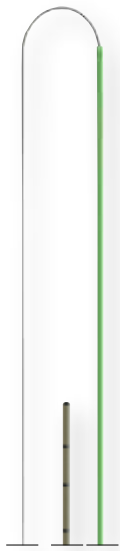

ANTIREFLUX VALVE URETERAL STENT

RÜSCH

TIP & EYE CONFIGURATION	REF. ACCORDING TO LENGTH OF STRAIGHT PART						ORDER SIZE	QTY
	10 CM	12 CM	15 CM	18 CM	20 CM	22 CM		
cylindrical closed	FOR SIMULTANEOUS APPLICATIONS							
	335316*	335303	335304	335305	335306	335307	3/4 Ch.	2
central opening	FOR COAXIAL APPLICATIONS							
	-	335403	335404	335405	335406	335407	3/4 Ch.	2

* only in Ch. 4

INTEGRAL STENT



- made of polyurethane
- cm graduations
- completely radiopaque
- pigtail and drainage eyes as indicated in the table
- flexible guidewire made of stainless steel with PTFE coating, with fixed core, flexible safety tip and rigid tip, approx. 100 cm long in sets with cylindrical closed tip, approx. 150 cm long in sets with tip with central opening
- latex-free
- sterile
- single use

SET COMPONENTS

- ureteral stent
- 2 fixation clamps
- introducer made of polyurethane, green, approx. 45 cm long
- flexible guidewire
- patient card
- documentation label
- sterile packaging

Maximum diameter of guidewire for paediatric integral stents with central opening

REF. 334700 / 334704 / 334705 / 334706 / 334760		
3 Ch.	4 Ch.	4.8 Ch.
0.018"	0.028"	0.028"

INTEGRAL STENT

RUSCH

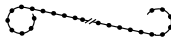
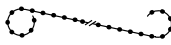
TIP & EYE CONFIGURATION	REF. ACCORDING TO LENGTH OF STRAIGHT PART					ORDER SIZE	QTY
	12 CM	15 CM	18 CM	20 CM	22 CM		
cylindrical closed 	FOR SIMULTANEOUS APPLICATIONS						
	334207	334231	334245	334232	334263	3/4/4.8 Ch.	5
central opening 	FOR COAXIAL APPLICATIONS						
	334700	334704	334705	334760	334706	3/4/4.8 Ch.	5

SURGERY

With famous brands such as RÜSCH, TAUT and WECK we can offer you an extraordinary range of surgical instruments that can be applied in such a highly specialised area as paediatric surgery.

Our product portfolio includes a bladeless trocar, a safe and easy-to-use skin stapler, advanced implantable ports plus Huber needles, feeding tubes and stomach tubes.

Thanks to the unique state-of-the-art design, every single device proves to serve surgeons' and patients' needs as well. This is true with regard to handling, functionality and efficiency of the device, thus keeping stress to a minimum and providing the young patient's quick recovery.



LAPAROSCOPIC SURGERY

Bladed trocar injury is the number one cause of complications in laparoscopic surgery. However, the innovative tip design of our TAUT Adapt access port minimises fascial damage to the patient.

The other device displayed on this page, the WECK Visistat Skin stapler, offers many benefits, too. For example a

see-through window for better visibility and a patented non-stop feed action for easy release and less jamming. Both instruments suit the varied challenges faced in minimally invasive or routine surgery to the greatest possible extent.

ADAPT

ASYMMETRICAL DILATING ACCESS PORTS WITH "FLOATING SEAL"

By eliminating blades and providing a tip that passes through tissue without cutting, our Taut ADAPt asymmetrical dilating access ports avoid injury and leave a 58% smaller defect than the most commonly used bladed trocars.* The duckbill valve provides reliable backflow prevention, while the cannula's transparency ensures unobstructed view.

- atraumatic tip
- transparent cannula
- duckbill valve
- "arrow on arrow" clip

ADAPT TROCARS, 5 MM

TAUT

REF.	Ø CANNULA	LENGTH	Ø INSTRUMENT	QTY
40507	5 mm	70 mm	5 mm	1
43507	5 mm	70 mm	3 mm–5 mm	1



* Munro, M.G., Tarnay, C.M. 2003. Comparative Evaluation of Laparoscopic Access Systems: A study of entry force, intraperitoneal pressure and incisional characteristics with a novel bladeless design (An "ADAPt" and a composite dilating system ("VersaStep"). UCLA.

VISISTAT

SKIN STAPLER

- see-through window
- patented non-stop feed action
- pre-cock function for exact staple positioning
- 35 medical grade stainless steel staples
- 3 removers available

VISISTAT

WECK

REF.	DESCRIPTION	QTY
WK528135	stapler	6
WK525960	remover, stainless steel	36
WK525970	remover, plastic, brown	6
WK525980	remover, plastic, white	12



PORTS AND NEEDLES

Implantable ports have become the first choice in venous access devices when long-term access to the patient's vasculature is required. These devices have proven themselves to offer great advantages over tunnelled catheterisation, thus resulting in a high level of patient acceptance and patient care.

Our variegated POLYSITE® series of implantable port sets as well as the great array of accessories such as a selection of standard Huber needles, including a new generation of advanced needles with additional safety features – they all belong to the most advanced devices of their class currently on the market.

POLYSITE® IMPLANTABLE PORTS

POLYSITE® 1000

- port made of polyoxymethylene (POM) / resin, catheter made of silicone
- soft and reinforced outlet tube
- anti-kinking system for optimal safety
- simple and safe catheter connection
- non thrombogenic
- POM/resin reservoir:
 - low weight
- radiopaque
- MRI compatibility

POLYSITE® 1000 SET COMPONENTS

- 1 port + 1 radiopaque catheter
- 2 radiopaque connecting rings
(only 1 for the pre-connected references)
- 1 23 G straight Huber needle
- 1 catheter introducer
- 1 puncture needle
- 1 Ø 2.5 mm tunnelling device, 23 cm length
- 1 catheter rinse + 1 x 10 ml syringe



REF.	QTY
1004	1

VENOUS MINI PORT

PORT							SILICONE CATHETER			
BASE Ø	Ø	HEIGHT	Ø SEPTUM	THICKNESS SEPTUM	WEIGHT	INTERN. VOL.	I.D.	O.D.	LENGTH	INTERN. VOL. ML/10 CM
31 x 22.8 mm	17.6 mm	10.7 mm	10.3 mm	4.8 mm	4.5 g	0.25 ml	0.8 mm	1.65 mm	600 mm	0.06

* average flow rate in ml/min, under a 1 m column of water

POLYSITE® 2000

- port made of titanium / polyoxymethylene (POM), catheter made of silicone
- shaped design
 - good flat stability
 - non-traumatic angles
- easy to connect
- titanium/POM* association:
 - low weight
- radiopaque
- MRI & CT scan compatibility
- titanium reservoir: total compatibility with cytotoxic ingredients
- connection tolerates pressures of P = 4.5 bar

POLYSITE® 2000 SET COMPONENTS

- 1 port + 1 radiopaque catheter
- 2 radiopaque connecting rings (only 1 for Ref. 2105 ISP)
- 1 23 G straight Huber needle
- 1 catheter introducer
- 1 x 5 F peel-away sheath introducer with J guidewire (0.018", 40 cm)
- 1 puncture needle 18 G, 38 mm of usable length
- 1 Ø 2 mm tunnelling device, 18 cm length
- 1 catheter rinse + 1 x 10 ml syringe



REF.	PRECONNECTED	QTY
2005 ISP		1
2105 ISP	•	1

POLYSITE 2000 – VENOUS MICRO PORT

PORT						SILICONE CATHETER					
BASE Ø	HEIGHT	Ø SEPTUM	WEIGHT	Ø PULL-OUT ROD	INTERN. VOL.	I.D.	O.D.	LENGTH	INTERN. VOL. ML/10 CM	SHEATH INTRODUCER	FLOW RATE*
22 x 17 mm	8.7 mm	8.0 mm	2.9 g	0.7 mm	0.2 ml	0.65 mm	1.65 mm	600 mm	0.04	5 F	8.5 (22 G) 10.0 (20 G) 10.5 (19 G)

* average flow rate in ml/min, under a 1 m column of water

Infusion pressure resistance 4.5 bar

- ① Septum
- ② Portal body
- ③ Fixation system
- ④ Dead volume
- ⑤ Connecting ring
- ⑥ Catheter
- ⑦ Port pull-out rod

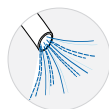

Optimum flow rate of 11 – 1.3l/h
(Ø port pull-out rod = Ø catheter)

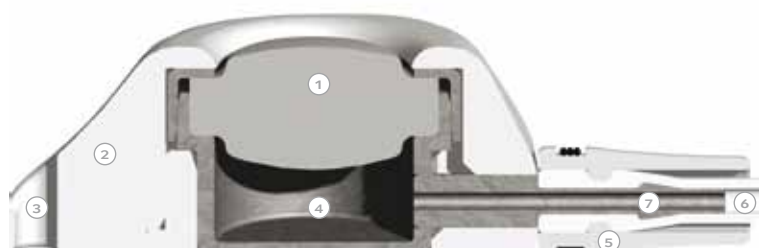

PPS® FLOW+

**NEW GENERATION OF SAFETY HUBER NEEDLE
AUTOMATIC POSITIVE PRESSURE**

AUTOMATIC POSITIVE PRESSURE UPON REMOVAL¹

- prevention of catheter obstruction:
catheter obstruction rate on implantable catheter port: 28 %²
- significant reduction in blood reflux at the distal tip of the catheter

SINGLE-HAND ACTIVATION

- 17 times fewer accidental puncture risks³
- protection against **pricking yourself**, as the needle is completely withdrawn into the piston

PREVENTION OF CATHETER-RELATED BLOODSTREAM INFECTION (CRBI)⁶

- BD Q-Syte™ closed Luer access device: maintains a sterile environment for the entire infusion line assembly

COST REDUCTION

- reduction in the use of fibrinolytic agents⁴
- reduction in cost following catheter obstruction complications⁵ (X-rays, nurse time, explantations, etc.)



PPS® FLOW+

REF.	Ø NEEDLE	GAUGE	USABLE LENGTH	USABLE LENGTH OF THE NEEDLE	QTY
721507	0.7 mm	22 G	25 mm	15 mm	50

¹ According to HAS guidelines, December 2000.

² Carlo JT et al., The American Journal of Surgery 188;722-727, 2004.

³ Survey of the occurrence circumstances of Accidental Blood Exposure due to punctures with safety materials, GERES – AFSSAPS Collaboration, G. Pellissier, 18th Annual GERES conference, 2008.

⁴ Lapalu J et al., Totally Implantable Port Management: Impact of positive pressure during needle withdrawal on catheter tip occlusion (An experimental study), Journal of Vascular Access, 2010; 11(1): 46-51.

⁵ Biffi R et al., Totally implantable central venous access ports for long-term chemotherapy, Annals of Oncology 9:767-773,1998.

⁶ Jarvis W et al., American Journal of Infection Control, Vol 33, Num 5, June 2005.

⁷ EC mark file.

⁸ Survey of the occurrence circumstances of Accidental Blood Exposure due to punctures with safety materials, GERES – AFSSAPS Collaboration, G. Pellissier, 18th Annual GERES conference, 2008.



HUBER NEEDLE

REF.	DESCRIPTION	Ø NEEDLE	GAUGE	USABLE LENGTH	RECOMMENDED FIELD OF USE	QTY
512506	straight	6/10 mm	23 G	25 mm	paediatric chemotherapy	50

GASTROENTEROLOGY

Whether it be feeding tubes or stomach tubes, RÜSCH's instruments for paediatric gastroenterology take the special needs of our small patients into consideration. They are available in small sizes and volumes, in short lengths

and made of the right materials. They are thus perfectly suited to the intra-abdominal structures of children, ensuring they are taken good care of in any clinical situation.

FEEDING TUBE

FOR PROLONGED PERIODS OF USE

- made of Wiruthan®
- cylindrical
- 2 eyes
- funnel with stopper
- sizes colour-coded (see table)
- length approx. 50 cm
- latex-free
- sterile
- single use



FEEDING TUBE

RÜSCH

REF.	ORDER SIZE	I.D. X O.D. (MM)	COLOUR	QTY
334000	1	1.0 x 1.5	yellow	10
	2	1.5 x 2.1	green	10
	3	1.7 x 2.5	red	10
	4	2.0 x 3.0	blue	10

SENGSTAKEN TUBE

STOMACH TUBE

- made of soft red rubber
- three-way
- cylindrical tip
- 2 Silkolatex Rüschi-Gold balloons with pilot balloons
- radiopaque ring between the balloons
- shaft fully radiopaque
- Luer syringe tips
- 4 suction eyes at the distal end of the tube
- length 65 cm
- graduated
- sterile
- single use

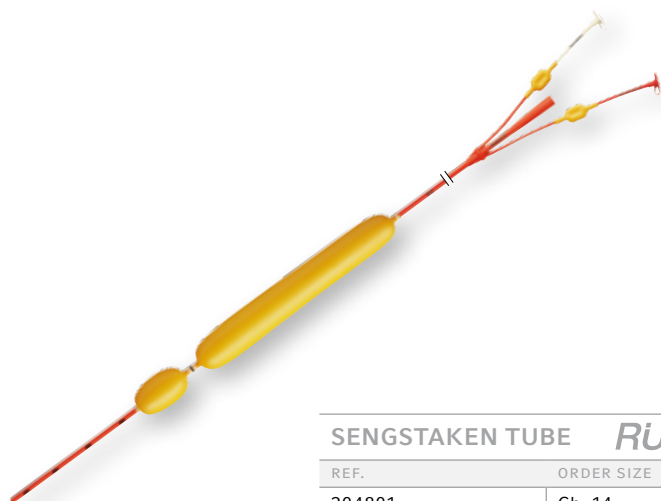

SENGSTAKEN TUBE RÜSCH

REF.	ORDER SIZE	QTY
204801	Ch. 14	2



TEMPERATURE MANAGEMENT

Teleflex's range of paediatric products for temperature management and monitoring during anaesthesia and in critical care features a complete range of products for the effective regulation of the child's temperature during and after operations. The rÜSCH Sensor, a transurethral Foley catheter for temperature measurement and a variety of warming covers to cater for all sizes provide you with a comprehensive solution to manage temperature and avoid the risk of hypothermia.

TEMPERATURE FOLEY

Our special temperature Foley catheter for urinary drainage is equipped with a sensor which continuously monitors the paediatric patient's temperature while simultaneously draining urine during and after operations and in intensive care. The special product design and high quality of the material employed ensure

optimum performance as well as high application comfort. The set includes a prefilled syringe which facilitates the inflation of the balloon and provides a high level of safety thanks to its steady and constant fill volume. A choice of reusable adapter cables complements this catheter.

RÜSCH SENSOR

FOLEY CATHETER FOR TEMPERATURE MEASUREMENT

- made of silicone, transparent
- 2 opposing eyes
- colour-coded shrink-sleeve for easy identification of size
- with prefilled syringe in sterile packaging (3 ml/5 ml sterile 10% glycerine solution) to inflate the balloon
- radiopaque cylindrical tip and contrast stripe
- latex-free
- sterile
- single use



RÜSCH SENSOR

RÜSCH

	REF.	ORDER SIZE	BALLOON	EYES	LENGTH (APPROX.)	QTY
	179360	Ch. 8	3 ml	2 opposing eyes	30 cm	5
		Ch. 10	5 ml	2 opposing eyes	30 cm	5

ADAPTER CABLES

	REF.	ADAPTER	LENGTH	QTY
	179312	Hospital plug, straight, for Datex Cardiocap, GE Hellige SMK, GE Eagle Dash, GE Solar 8000 M, Nihon Kohden Life Scope	5.0 m	1
	179313	Siemens round plug, 7-pole, for Hewlett Packard Vividia 24 C as well as for Dräger (Siemens): Infinity Delta XL, SC 7000, SC 8000, SC 9000	3.5 m	1
	179314	HP round plug, 2-pole, for Phillips: Intellie Vue, Sure Signs – VM Serie, MP 2, MP 5, MP 20, MP 30, MP 40, MP 60, MP 90	5.0 m	1
	179316	Alsius round plug, 2-pole, for CoolGard CG3000	5.0 m	1

CONVECTIVE WARMING SYSTEM

Many patients suffer from hypothermia during operations. The use of therapy warming systems for the reduction of intraoperative and post-operative hypothermia reduces the risk of costly complications and accelerates postoperative recovery. Convective warming systems have proven to be the most efficient and effective method of actively regulat-

ing the patient's temperature. The greatest benefit for the child is that as the dose of sedatives can then be reduced and the wakening phase is shortened, earlier discharge from the recovery room is possible. Our range of warming covers meets all requirements of therapy temperature management.

WARMING COVERS

Combined with the air-pressure control software, a selected perforation across the cover provides homogenous warming of the entire surface. The Sirocco tube is the lightest available on the market, due to its small diameter. As a result, the cover will not slip off the patient. The cover is made of soft comfortable material and adapts well to the characteristics of each individual child, thus offering optimum comfort. Sirocco warming covers can be covered intra-operatively with surgical drape or post-operatively with a normal cotton blanket. As they are very compact and extremely light, they can be used in various positions and are suitable for mobile use anywhere in the hospital. Due to easy handling, low maintenance and long durability this product has also proven to be very cost-effective.

- homogenous warming
- ergonomic design
- soft material
- compact and extremely lightweight
- safe, simple, comfortable
- high durability
- latex-free
- unsterile or sterile
- single use

SIROCCO NEONATAL WARMING COVERS

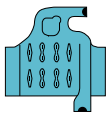
	REF.	DESCRIPTION	UNIVERSAL CONNECTION	VERSION	QTY
	GCNEN00050N	• for use under the body	no	unsterile	20
	GCOEN00050N	• suitable for intraoperative and postoperative use	no	sterile	20
	GCNEN0CA50N	• size functional area: 60 cm long, 60 cm wide	yes	unsterile	20
	GCOEN0CA50N	• size whole cover: 90 cm long, 82 cm wide	yes	sterile	20

SIROCCO POSTOPERATIVE PAEDIATRIC WHOLE-BODY COVER

	REF.	DESCRIPTION	UNIVERSAL CONNECTION	VERSION	QTY
	GCNEP00040P	• for the recovery room or the intensive care unit	no	unsterile	20
	GCOEP00040P	• cover can easily be folded back for unhindered access to patient	no	sterile	20
	GCNEP0CA40P	• size functional area: 74 cm long, 90 cm wide	yes	unsterile	20
	GCOEP0CA40P	• size whole cover: 141 cm long, 110 cm wide	yes	sterile	20

SIROCCO POSTOPERATIVE WHOLE-BODY COVER FOR LARGER CHILDREN

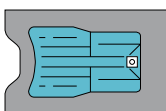
	REF.	DESCRIPTION	UNIVERSAL CONNECTION	VERSION	QTY
	GCNEC00010C	• for the recovery room or the intensive care unit	no	unsterile	20
	GCOEC00010C	• cover can easily be folded back for unhindered access to patient	no	sterile	20
	GCNEC0CA10C	• size functional area: 158 cm long, 92 cm wide	yes	unsterile	20
	GCOEC0CA10C	• size whole cover: 230 cm long, 160 cm wide	yes	sterile	20

READ UP ON OUR PRODUCT RANGES

MORE SIZES!
MORE
PRODUCTS!

Simply cut out this card and send it to us, or go to www.teleflex.com/emea and click on Services to download information material.



PLEASE TICK REQUESTED MATERIAL

- ARTERIAL & VENOUS ACCESS
- FILTRATION & HUMIDIFICATION
- THORAX DRAINAGE SYSTEMS
- OXYGEN & AEROSOL THERAPY
- TRACHEOSTOMY
- AIRWAY MANAGEMENT
- REGIONAL ANAESTHESIA
- UROLOGY
- SURGERY
- TEMPERATURE MANAGEMENT

Teleflex is a leading global provider of specialty medical devices used for diagnostic and therapeutic procedures in critical care, urology and surgery. Our mission is to provide solutions that enable healthcare providers to improve outcomes and enhance patient and provider safety. We specialise in devices for general and regional anaesthesia, cardiac care, respiratory care, urology, vascular access and surgery and we serve healthcare providers in more than 130 countries. Teleflex also provides specialty products for medical device manufacturers.

Our well known brands include ARROW®, BEERE MEDICAL®, DEKNATEL®, GIBECK®, HUDSON RCI®, KMEDIC®, PILLING®, PLEUR-EVAC®, RÜSCH®, SHERIDAN®, SMD®, TAUT®, TFX OEM®, VASONOVA™ and WECK®, all of which are trademarks or registered trademarks of Teleflex Incorporated.

Teleflex global operations: Austria, Belgium, Canada, China, Czech Republic, France, Germany, Greece, India, Ireland, Italy, Japan, Mexico, Netherlands, Portugal, Singapore, Slovak Republic, South Africa, Spain, Switzerland, United Kingdom, Uruguay and USA.

YOUR CONTACTS FOR EUROPE, THE MIDDLE EAST AND AFRICA (EMEA):

TELEFLEX HEADQUARTERS EMEA, IRELAND

Teleflex Medical Europe Ltd., IDA Business Park, Athlone, Co. Westmeath
Phone +353 (0)9 06 46 08 00 · Fax +353 (0)14 37 07 73
orders.intl@teleflex.com

AUSTRIA +43 (0)1 402 47 72

BELGIUM +32 (0)2 333 24 60

CZECH REPUBLIC +420 (0)495 759 111

FRANCE +33 (0)5 62 18 79 40

GERMANY +49 (0)7151 406 0

GREECE +30 210 67 77 717

ITALY +39 0362 58 911

NETHERLANDS +31 (0)88 00 215 00

PORTUGAL +351 22 541 90 85

SLOVAK REPUBLIC +421 (0)3377 254 28

SOUTH AFRICA +27 (0)11 807 4887

SPAIN +34 918 300 451

SWITZERLAND +41 (0)31 818 40 90

UNITED KINGDOM +44 (0)1494 53 27 61

For detailed information see www.teleflex.com

The products in this catalogue are only available in the EMEA (Europe, Middle East, Africa) region. For further information contact your local representative. All data current at time of printing (06/2012). Subject to technical changes without further notice.

94 05 64 - 00 00 01 · REV B · MC / WM · 06 12 03

Institution

Name

Street

Postal code

City

Telephone

E-mail

Please use
a stamp

Reply to

Teleflex Medical Europe Ltd.

Customer Service

IDA Business and Technology Park

Dublin Road, Athlone

Co Westmeath

Ireland

Yes, please send me the
information material
ticked on the other side

Yes, I would like to
arrange a date with a
Teleflex representative

